

EU-MIDIS II

Second European Union Minorities and Discrimination Survey

Technical report



***Europe Direct is a service to help you find answers
to your questions about the European Union***

Freephone number (*):
00 800 6 7 8 9 10 11

(* The information given is free, as are most calls (though some operators, phone boxes or hotels may charge you).

More information on the European Union is available on the internet (<http://europa.eu>).

Luxembourg: Publications Office of the European Union, 2017

FRA – print: ISBN 978-92-9491-764-5 doi:10.2811/546676 TK-02-17-830-EN-C

FRA – web: ISBN 978-92-9491-763-8 doi:10.2811/326094 TK-02-17-830-EN-N

© European Union Agency for Fundamental Rights, 2017

Reproduction is authorised provided the source is acknowledged. For any use or reproduction of photos contained herein, permission must be sought directly from the copyright holder.

Printed by Imprimerie Centrale in Luxembourg

PRINTED ON ELEMENTAL CHLORINE-FREE BLEACHED PAPER (ECF)

Second European Union Minorities and Discrimination Survey

Technical report

Acronyms

AAPOR	American Association for Public Opinion Research
ACS	Adaptive cluster sampling
CAPI	Computer-assisted personal interviewing
CCT	Central coordination team
CEH	Confirmed eligible household
CIH	Confirmed ineligible household
CIS	Sociological Research Centre
CS	Contact sheet(s)
DEGURBA	Degree of urbanisation
EFTA	European Free Trade Association
EU	European Union
EU-MIDIS II	Second wave of the European Union Minorities and Discrimination Survey
Eurostat	Statistical office of the European Commission
EU-SILC	European Union Statistics on Income and Living Conditions
FE	Focused enumeration
FRA	European Union Agency for Fundamental Rights
HH	Household
ISCED	International Standard Classification of Education
ISTAT	Italian National Institute of Statistics
LAU	Local administrative unit
LFS	Labour Force Survey
LGBT	Lesbian, gay, bisexual and transgender
MIDIS	Minorities and Discrimination Survey
NGO	Non-governmental organisation
NSE	National survey expert
NSI	National statistical institute
NUTS	Nomenclature of territorial units for statistics
OECD	Organisation for Economic Co-operation and Development
PAPI	Paper and pencil interview
PPS	Probability proportional to size
PSU	Primary sampling unit
TRAPD	Translation, review, adjudication, pre-test and documentation

Country and target group codes

Country	EU Member State	Country target group code	Target group
AT	Austria	AT - TUR	Immigrants and descendants of immigrants from Turkey
		AT - SSAFR	Immigrants and descendants of immigrants from Sub-Saharan Africa
BE	Belgium	BE - TUR	Immigrants and descendants of immigrants from Turkey
		BE - NOAFR	Immigrants and descendants of immigrants from North Africa
BG	Bulgaria	BG - ROMA	Roma
CY	Cyprus	CY - ASIA	Immigrants and descendants of immigrants from Asia
CZ	Czech Republic	CZ - ROMA	Roma
DE	Germany	DE - TUR	Immigrants and descendants of immigrants from Turkey
		DE - SSAFR	Immigrants and descendants of immigrants from Sub-Saharan Africa
DK	Denmark	DK - TUR	Immigrants and descendants of immigrants from Turkey
		DK - SSAFR	Immigrants and descendants of immigrants from Sub-Saharan Africa
EE	Estonia	EE - RUSMIN	Russian minority
EL	Greece	EL - ROMA	Roma
		EL - SASIA	Immigrants and descendants of immigrants from South Asia
ES	Spain	ES - ROMA	Roma
		ES - NOAFR	Immigrants and descendants of immigrants from North Africa
FI	Finland	FI - SSAFR	Immigrants and descendants of immigrants from Sub-Saharan Africa
FR	France	FR - NOAFR	Immigrants and descendants of immigrants from North Africa
		FR - SSAFR	Immigrants and descendants of immigrants from Sub-Saharan Africa
HR	Croatia	HR - ROMA	Roma
HU	Hungary	HU - ROMA	Roma
IE	Ireland	IE - SSAFR	Immigrants and descendants of immigrants from Sub-Saharan Africa
IT	Italy	IT - SASIA	Immigrants and descendants of immigrants from South Asia
		IT - NOAFR	Immigrants and descendants of immigrants from North Africa
		IT - SSAFR	Immigrants and descendants of immigrants from Sub-Saharan Africa
LT	Lithuania	LT - RUSMIN	Russian minority
LU	Luxembourg	LU - SSAFR	Immigrants and descendants of immigrants from Sub-Saharan Africa
LV	Latvia	LV - RUSMIN	Russian minority
MT	Malta	MT - SSAFR	Immigrants and descendants of immigrants from Sub-Saharan Africa
NL	Netherlands	NL - TUR	Immigrants and descendants of immigrants from Turkey
		NL - NOAFR	Immigrants and descendants of immigrants from North Africa
PL	Poland	PL - RIMGR	Recent immigrants
PT	Portugal	PT - ROMA	Roma
		PT - SSAFR	Immigrants and descendants of immigrants from Sub-Saharan Africa
RO	Romania	RO - ROMA	Roma
SE	Sweden	SE - TUR	Immigrants and descendants of immigrants from Turkey
		SE - SSAFR	Immigrants and descendants of immigrants from Sub-Saharan Africa
SI	Slovenia	SI - RIMGR	Recent immigrants
SK	Slovakia	SK - ROMA	Roma
UK	United Kingdom	UK - SASIA	Immigrants and descendants of immigrants from South Asia
		UK - SSAFR	Immigrants and descendants of immigrants from Sub-Saharan Africa



Contents

ACRONYMS	3
COUNTRY AND TARGET GROUP CODES	4
INTRODUCTION	7
Report structure	9
1 DEVELOPING THE SURVEY	11
1.1. Stakeholder and survey expert consultations	11
1.2. Cognitive pre-test study	12
1.3. EU-MIDIS II target groups	14
1.4. Project management	15
2 DEVELOPMENT AND TRANSLATION OF FIELDWORK MATERIAL AND SURVEY TOOLS	17
2.1. Questionnaire development	17
2.2. Questionnaire translation	20
Step 1. Translatability assessment	21
Step 2. Two translations prepared in parallel	21
Step 3. Adjudication	21
Step 4. Adjudication meeting	21
Step 5. Final proofreading	22
Step 6. Automated checks	22
2.3. Development and translation of other survey material	22
Respondent-friendly paper version questionnaires	22
Showcards	22
Contact sheets	22
Interviewer training manual	23
Introductory letter and postcard	23
3 INTERVIEWER SELECTION AND TRAINING	25
3.1. Central project briefing	25
3.2. Interviewer selection and training	25
4 SAMPLING	29
4.1. Target populations and sample requirements	29
Immigrants and descendants of immigrants in EU-MIDIS II	30
Ethnic minorities in EU-MIDIS II	33
4.2. Sample sizes	33
Roma target group	34
Immigrants and descendants of immigrants from North Africa	36
Immigrants and descendants of immigrants from South Asia	36
Immigrants and descendants of immigrants from Sub-Saharan Africa	37
Recent immigrants	38
4.3. Sample frames and mapping of available information for sampling	38
4.4. Overview of sampling methodologies used	43
Coverage and efficiency of design	43
4.5. Direct single-stage sampling (design 1)	49
4.6. Multi-stage area sampling (designs 2a, 2b, 2c)	49
Oversampling concentration strata	50
Selection of addresses	52
Random route	52
Focused enumeration	55

Adaptive cluster sampling	56
Stopping and dropping rules	57
Sampling by referrals	58
Selection of dwelling units, households and individuals	58
Managing fieldwork targets	58
4.7. Location sampling (design 3)	59
Regional mapping, selection of regions and sample allocation	59
Listing centres in each region	59
Selection of locations for inclusion in fieldwork	60
4.8. Non-probability sampling (design 4)	61
5 PILOTING	63
5.1. Methodology	63
5.2. Key findings, recommendations and action taken as a result of the pilot	64
Sampling	64
Gaining respondent cooperation	66
Contact sheets	66
Questionnaire	66
6 FIELDWORK	69
6.1. Fieldwork dates and progress	69
6.2. Contacting respondents – recruitment and interview format	71
6.3. Interview length	73
6.4. Fieldwork support material	75
6.5. Fieldwork outcomes	76
6.6. Field force and fieldwork control	78
6.7. Data processing and data cleaning	80
7 WEIGHTING	83
7.1. Weighting procedures: clustered and unclustered samples (sample designs 1 and 2)	83
Design weights	83
PSU selection (clustered samples)	83
Non-response weights	85
Post-stratification or calibration (individual and household) and final weights	86
Trimming weights	87
7.2. Weighting procedures – location sampling (sample design 3)	87
Calculations for locations	88
Individual weight	88
Post-stratification weight	89
7.3. Weighting procedures – quota sampling (sample design 4)	89
7.4. Weighting efficiency	89
8 LESSONS LEARNED	91
ANNEX 1: QUESTIONNAIRE FLOWCHART	95
ANNEX 2: LOCAL CONTRACTORS FOR FIELDWORK	96
ANNEX 3: QUALITY ASSURANCE PLAN	97
REFERENCES	105



Introduction

The European Commission developed a European Union (EU) Framework to guide national Roma integration strategies in April 2011, and in December 2013 the Council of the European Union provided detailed recommendations for enhancing the effectiveness of national measures. In parallel, and for the first time, the legal framework of the EU's main investment policy tool, the European Structural and Investment Funds, allocated €454 billion for 2014–2020, included a specific ex-ante conditionality for allocating funds under the thematic objective on social inclusion and poverty. There is increasing awareness among EU institutions and relevant stakeholders in individual Member States of the need for robust data to underpin policies and investments that aim to improve the situation and integration of Roma.¹ In December 2013, the European Parliament urged Member States “to produce disaggregated data with the assistance of the European Agency for Fundamental Rights (FRA) and to develop, in cooperation with the Commission, the baseline indicators and measurable targets that are essential for a robust monitoring system in order to ensure reliable feedback on the progress made in the implementation of the National Roma Integration Strategies and in improvement of the situation of Roma”.² In 2016, the European Court of Auditors issued a special report to assess the impact of EU policy initiatives and financial support on Roma integration.³ Recommendation 8 (b) of this report calls on the European Commission to encourage Member States to collect comprehensive statistical data on ethnicity within the next 2 years. It further suggests that Eurostat could include relevant questions in the EU Statistics on Income and Living Conditions (EU-SILC) and its Labour Force Survey (LFS). The European Commission, however, rejected this recommendation, commenting that collecting statistical data on ethnicity through European statistical instruments is technically difficult, expensive and legally challenging in some countries.⁴

FRA's mandate is to provide the relevant institutions, bodies, offices and agencies of the EU and its Member States with independent, evidence-based assistance and expertise relating to fundamental rights. Data collection (including comparative data collection in the form of survey research) on the situation of fundamental rights in the EU provides the basis for FRA's assistance and expertise. For several years, FRA has promoted the collection of data that 1) can be disaggregated by ethnic origin; 2) are based on information about respondents' self-identification; and 3) are collected on

a voluntary basis and fully respecting EU and national data protection regulations. In this context, FRA regularly conducts surveys on members of ethnic, religious and other minorities, including the Second European Union Minorities and Discrimination Survey (EU-MIDIS II).⁵

Article 17 of the Racial Equality Directive requires Member States, every 5 years, to communicate to the European Commission all the information necessary for the Commission to draw up a report for the European Parliament and the Council of the EU on the application of this directive. In doing so, the European Commission shall take FRA's views into account.⁶ FRA has identified various factors that prevent more effective implementation of legal provisions and other mechanisms designed to improve protection against discrimination. For example, FRA collects existing official data related to racism, xenophobia and other intolerance in the field of racist and racism-related hate crimes, and has consistently shown that not all Member States collect and/or publish comprehensive official data on such incidents. The reasons are complex. They reflect, among other things, the cultural and historical response to 'racist' and related crimes in the individual country. Where such data have been collected, divergent legal definitions that have determined the scope of data collection, the purpose for which data are intended, and diverse methodologies for data collection have all impeded direct comparisons. FRA undertakes scientific research and data collection on selected population groups, in line with EU policy priorities and where FRA research would have added value. FRA enriches methodological development with its rights-based approach to data collection and its expertise in comparative EU-wide survey design, given that Europe's increasingly diverse populations present a challenge to traditional survey research. This means that we need to develop and adopt survey methods that capture the experiences of persons belonging to vulnerable groups, including those categorised as 'hard to reach'. 'Hard to reach', 'elusive' or 'hidden' populations are socially disadvantaged and disenfranchised groups that are difficult to access, engage and retain in research cost efficiently and in large numbers.⁷ FRA is the organisation that surveys them most.⁸

FRA has launched several surveys to compensate for the absence of official data and to document the situation on manifestations of discrimination, racism and related intolerance more generally (beyond the specific field of hate crime). In 2015, it launched EU-MIDIS II to

1 FRA and United Nations (2016).

2 European Commission (2014).

3 European Court of Auditors (2016).

4 FRA (2016).

5 FRA and United Nations (2016).

6 Council of the European Union (2000), Art. 17 (2).

7 See, for example, Bonevski, B. *et al.* (2014); Reichel, D. and Morales, L. (2017).

8 FRA and United Nations (2016).

assess progress made since the first wave of the survey. The first EU-MIDIS survey was in 2008, and the first results appeared in 2009.⁹ It was the largest EU-wide survey, and the first of its kind. It interviewed a random sample of 23,500 immigrants and minority ethnic groups, such as Roma, face to face concerning their experiences of discrimination, racist victimisation and awareness of rights.

This second wave of EU-MIDIS collected comparable data in all 28 EU Member States in 2015–2016, to assist EU institutions and policy makers in developing evidence-based legal and policy responses to respect, protect and fulfil the rights of persons with immigrant or ethnic minority backgrounds, including Roma. The survey explores a range of issues concerning discrimination based on grounds prohibited by international human rights law, such as skin colour, ethnic origin, religion or religious belief, as well as respondents' experience of harassment, hate-motivated violence and experiences of discriminatory profiling. Other thematic areas that EU-MIDIS II covers include rights awareness, civic and political participation, and experiences of corruption and inter-group relations. The survey also collected a number of relevant demographic characteristics at the level of both individuals and households, to facilitate analysis of immigrants and ethnic minorities' housing, income and living conditions. The results of this work provide valuable evidence on the impact of EU and national social inclusion efforts. This helps policy makers develop targeted responses in the absence of other surveys that would enable us to compare fundamental rights outcomes for immigrants and ethnic minorities across the EU.

The overall objectives of EU-MIDIS II are 1) to collect comparable data in all 28 EU Member States to support the EU in protecting the fundamental rights of persons with immigrant or ethnic minority backgrounds, including Roma; 2) to refine research methodologies for sampling and surveying hard-to-reach groups; 3) to populate core indicators for measuring progress in the implementation of the EU Framework for National Roma Integration Strategies and selected indicators on immigrant integration; 4) to enable analysis of trends over time where possible; and 5) to deliver results, analysis and FRA opinions that meet the needs of the survey's key stakeholders.

To achieve these objectives, EU-MIDIS II interviewed 25,500 persons with immigrant or ethnic minority backgrounds across the EU, including Roma, in nine EU Member States. Experienced, trained interviewers interviewed respondents from the selected target group(s) face to face. In each country, one to three groups were selected for the survey, and interviewees were chosen

using random probability sampling methods and interviewed using computer-assisted personal interviewing (CAPI), either at home or in locations that the target groups frequented. The main reference design in EU-MIDIS II is a household-based survey of individual persons. The data collection methodology used in EU-MIDIS II built upon experience gained from carrying out FRA's first survey on immigrants and ethnic minorities in 2008 (EU-MIDIS I), the Roma survey in 2011¹⁰ and FRA's other surveys collecting data on specific minority groups, such as Jewish people or lesbian, gay, bisexual and transgender (LGBT) persons, or issues, such as violence against women. Compared with earlier surveys, the set of questions was extended in EU-MIDIS II and it improved the coverage of the survey's target groups through the use of refined sampling methodologies.

Following an EU-wide open call for tenders, FRA commissioned Ipsos MORI, a large international survey company based in the United Kingdom, to coordinate data collection in all 28 EU Member States under the supervision of FRA staff, who monitored compliance in accordance with strict quality control procedures. As an illustration, while Ipsos MORI organised the implementation of the fieldwork by subcontracting national research agencies in each country, FRA staff participated in interviewer training sessions and observed data collection activities in selected Member States.

In surveying hard-to-reach populations, EU-MIDIS II faced a number of challenges during its implementation. Unexpected events, including negative political rhetoric and measures with respect to the refugee crisis, and the terrorist attacks in Paris in 2015 and Brussels in 2016, created difficulties during fieldwork, especially in those Member States where immigrants and descendants of immigrants were surveyed. One of the main challenges when surveying hard-to-reach groups is the lack of, or deficiencies in, sampling frames – that is, lists or registers of persons or households that could be used for sampling purposes. A cross-country and/or cross-cultural survey design introduces additional complexity for surveying immigrants and ethnic minorities, as the proportions of different ethnic groups and their overall composition might vary across the countries surveyed.

The fieldwork was commissioned in December 2014 with a view to delivering all outputs within 16 months of the contract signature. However, it needed an additional 6 months to complete all the activities, because of the time needed to improve the sample designs and secure access to sampling frames from national statistical institutes (NSIs), the general complexity of the project design and associated survey tools, and a lower than expected concentration of the target population in some countries. The terrorist attacks in Paris and

⁹ FRA (2009).

¹⁰ FRA (2013).



Brussels produced a more difficult and less safe environment for carrying out the interviews in some areas. These issues resulted in a longer fieldwork period than had initially been planned.

Report structure

This technical report provides the relevant information needed to assess the quality and reliability of the EU-MIDIS II survey data, as well as considerations for interpreting the survey results. Survey researchers often assess quality in terms of absence or presence of various types of bias, which affect all surveys. The various sections of this technical report clearly identify potential sources of bias, stemming from survey design or decisions made when implementing the survey. Given the innovative nature of the survey and the advanced methods used in balancing costs with potential sources of bias, this report can also be used as a reference when developing other national or multinational surveys on immigrants and ethnic minorities. The following chapters of the report cover the procedures used in the development and administration of the survey.

The first three chapters of this report describe and assess the various stages of developing the methodological design of the survey, and the approach to developing interview content (i.e. questionnaire, showcards and other data collection tools) and other interviewer material ([Chapter 1](#)); the translation process ([Chapter 2](#)); and the approach to interviewer selection and training ([Chapter 3](#)).

In most countries where an address-based sampling approach was the primary sampling approach used, this was supplemented with a secondary sampling method: 1) adaptive cluster sampling (ACS), or 2) focused enumeration (FE). [Chapter 4](#) provides full sampling details for each country.

The survey was piloted before the main-stage fieldwork in all 28 Member States, to test the questionnaire, all fieldwork material and sampling approaches. [Chapter 5](#) discusses the methodology of the pilot and the resulting amendments to the fieldwork material and sampling. [Chapter 6](#) describes the main-stage fieldwork, with details concerning the achieved sample as well as fieldwork progress, procedures and outcomes. [Chapter 7](#) explains the weighting applied to the data.

1

Developing the survey

The development of the EU-MIDIS II survey started in 2013 with comprehensive research on existing international and national surveys among immigrants and ethnic minorities, as well as the development of the questionnaire. FRA hosted expert and stakeholder consultations at its premises, involving representatives from EU institutions, international organisations, civil society and academia. In addition, a cognitive pre-test study was conducted in 2014 based on a draft questionnaire. This study was implemented in eight EU Member States to test selected questions and other fieldwork material needed for the full-scale survey. The results of the pre-test study informed the further development of the survey questionnaire, which was finalised in the beginning of 2015. In January 2015, FRA organised a second expert consultation meeting to inform the development of the full-scale survey, with the participation of 17 survey experts.

1.1. Stakeholder and survey expert consultations

FRA set out to ensure that the content of the survey meets the needs of policy makers at both EU and Member State levels, and contributes to filling the gap in the availability of data concerning immigrants and ethnic minorities' experiences of discrimination, racist victimisation and related intolerance more generally (beyond the specific field of hate crime).

The first stakeholder meeting, in March 2014, gathered 21 stakeholders representing EU institutions, international organisations, civil society and academia as follows:

- European Commission – Directorate-General for Justice and Consumers, Unit C1 – Fundamental rights and rights of the child
- European Parliament – Policy Department Citizens' Rights and Constitutional Affairs
- European Commission – Eurostat, Unit F2 – Population
- Council of Europe
 - European Commission against Racism and Intolerance (ECRI)
 - Roma and Travellers Division, Committee of Experts on Roma and Travellers (MG-S-ROM)
- Organisation for Security and Co-operation in Europe, Office for Democratic Institutions and Human Rights (OSCE-ODIHR)
- EQUINET – European Network of Equality Bodies
- ENAR – European Network against Racism
- PICUM – Platform for International Cooperation on Undocumented Migrants
- MPG – Migration Policy Group
- ICMPD – International Centre for Migration Policy Development
- CCIF – Collective Against Islamophobia in France
- ERRC – European Roma Rights Centre
- CRAN – Conseil Représentatif des Associations Noires
- Muslim Council of Britain – Research and Documentation Centre
- Office of the Greek Ombudsman

- Centre for Equal Opportunities and Opposition to Racism
- Centre for Policy Studies, Central European University
- Centre of Migration Research, University of Warsaw.

The meeting focused on identifying thematic areas and issues relevant to the survey, and the target groups that should be covered in the research. The experts brought in their various perspectives and expertise to discussions on the survey's content and scope. The valuable contributions and issues raised during the meeting were highly beneficial for the development of EU-MIDIS II.

Immediately after that, there was an expert meeting involving 13 survey research experts. This meeting concentrated on practical challenges related to the survey, from questionnaire design to sampling and fieldwork methods. The list of leading specialists in the area of survey research who attended the meeting included (in alphabetical order by surname) Aniko Bernat (TARKI Social Research Institute, Budapest), Gian Carlo Blangiardo (Department of Statistics and Quantitative Research, University of Milan), Agata Gorny (Centre of Migration Research, University of Warsaw), Inga Jasinskaja-Lahti (Department of Social Psychology, University of Helsinki), Piotr Juchno (Eurostat, Unit F2 – Population), Martin Kroh (Institute for Social Sciences, Humboldt University Berlin), Mónica Méndez Lago (Sociological Research Centre (CIS), Madrid), Marwan Muhammad (spokesman for the Collective Against Islamophobia in France (CCIF), Silke Schneider (GESIS – Leibniz Institute for the Social Sciences), Philipp Schnell (Institute for Urban and Regional Research, Austrian Academy of Sciences), Rainer Schnell (Institute of Sociology, University of Duisburg Essen), Julia Szalai (Centre for Policy Studies, Central European University) and Vijay Verma (Department of Economics and Statistics, University of Siena).

In January 2015, FRA hosted another two-day expert meeting to discuss the questionnaire, and key methodological aspects of the survey such as sampling frames and sampling design. The meeting gathered 17 survey experts representing EU institutions, international organisations, civil society and academia, including (in alphabetical order) Iris Andriessen (The Netherlands Institute for Social Research), Johann Bacher (Johannes Kepler University, Linz), Aniko Bernat (TARKI Social Research Institute, Budapest), Gian Carlo Blangiardo (Department of Statistics and Quantitative Research, University of Milan-Bicocca), Han Entzinger (FRA Scientific Committee), Claudia Ionela Grosu (National Roma Agency, Romania), Kenneth Horvath (University of Education, Karlsruhe), Thomas Huddleston (Migration Policy Group, Brussels), Piotr Juchno (Eurostat, Unit F2

– Population), Tadas Leoncikas (Eurofound), Thomas Liebig (International Migration Division, Directorate for Employment, Labour and Social Affairs, Organisation for Economic Co-operation and Development (OECD)), Agnieszka Litwińska (Eurostat, Unit F4 – Quality of Life), Farhad Mehran (independent expert, formerly International Labour Organization (ILO)), Mónica Méndez Lago (CIS, Madrid), Laura Morales (Department of Politics and International Relations, University of Leicester), Patrick Simon (National Institute for Demographic Studies (INED), Paris) and Chris Skinner (Department of Statistics, London School of Economics and Political Science).

The experts acknowledged the challenge of obtaining a representative probability sample of the target populations, due to the general absence of sampling frames in most countries. They discussed a variety of alternative sampling methods, including focused enumeration, adaptive cluster sampling, location sampling ('centre sampling'), telephone name sampling and respondent-driven sampling (RDS). The use of focused enumeration, adaptive cluster sampling and location sampling were deemed feasible alternative sampling methods, but there was also scepticism about the use of respondent-driven sampling in the context and time frame of the project.

1.2. Cognitive pre-test study

In preparation for the second EU-MIDIS survey, FRA published an open call for tender, as a result of which it commissioned Ipsos MORI in 2014 to cognitively pre-test a questionnaire in eight EU Member States with the objectives to:

- develop and improve the EU-MIDIS survey questionnaire;
- explore the feasibility of collecting valid, reliable and comparable information through a population-based survey of selected immigrant and ethnic minority groups;
- report the findings to develop a 'best-practice' model.

To meet these objectives, the pre-test used qualitative, cognitive testing methods to investigate the ways in which respondents in different EU Member States understand key concepts related to their fundamental rights. More specifically, questions were tested to understand their fitness for purpose in terms of measuring and describing respondents' experiences of discrimination and crime victimisation, and their living conditions. The eight EU Member States selected for the pre-test were Belgium, Croatia, Greece, Hungary, Italy, Malta, Romania and the United Kingdom.



The questions selected by FRA for pre-testing – the interview content – were first developed by FRA and then further developed in cooperation with Ipsos MORI's central research team.

In the next step, FRA asked nine academic experts, specialised in questionnaire design and/or research with ethnic minority and migrant groups, to provide written feedback on the pre-test questionnaire. The experts included Barbara Herzog-Punzenberger (Federal Institute for Research in Education, BIFIE Austria), Kenneth Horvath (University of Education, Karlsruhe), Gijs van Houten (Eurofound), Mónica Méndez Lago (Centro de Investigaciones Sociológicas, Madrid), Alita Nandi (Institute for Social and Economic Research, University of Essex), Peter Schmidt (Justus Liebig University, Gießen), Ilona Tomova (Institute for Population and Human Studies, Bulgarian Academy of Sciences), Georgios Tsiakalos (Aristotle University, Thessaloniki) and Malina Voicu (GESIS – Leibniz Institute for the Social Sciences). Experts were asked to provide written feedback on selected questions using a structured, evaluative framework that asked them to consider each question in terms of:

- (1) The content standard: Does the question ask the right thing? Will answers to this question measure what is intended?
- (2) The cognitive standard: Will the question make sense to respondents? Will respondents be able to answer it accurately?
- (3) The usability standard: Can this question be easily read aloud/administered in respondents' homes?¹¹

Following their written feedback, the nine experts were invited to a pre-test Expert Panel Meeting, which was held in Vienna on 20–21 February 2014. The purpose of the meeting was to discuss the feedback from the academic experts, to develop and improve the EU-MIDIS II questionnaire ahead of its cognitive pre-testing in the field. Prior to the event, each expert was sent the draft pre-test questionnaire with comments, including issues to be discussed over the course of the two-day meeting.

The input of experts into the development of the interview content was valuable: their expertise facilitated a broad-based, structured assessment of the interview content, which considered the coherence of each question, as well as the likely challenges of use in the field, particularly when interviewing Roma.

Following the expert consultation, the central research team of Ipsos MORI summarised the feedback to

formulate recommendations for action to take on each survey question assessed by the experts.

In preparation for the cognitive testing, FRA and Ipsos MORI developed a detailed probing approach to test respondents' comprehension related to the survey questions. Tailored probes were inserted after each question to allow the respondents, after having answered the question, to explain in their own words the way they understood the question or certain terms used. After FRA's approval the final version of the pre-test questionnaire was translated into eight languages used in the pre-test.

As a part of the pre-test study, 280 cognitive interviews were conducted between January and July 2014 with people from diverse backgrounds, including Roma. While it was not a requirement to test every question in each interview, it was required that each interview cover a certain number of sections of the pre-test questionnaire. The final version of the pre-test questionnaire included 173 questions, 15 of which varied across respondents.

The pre-test findings showed that designing questions to measure prevalence of discrimination, physical violence and harassment among immigrants and minorities is challenging, because one has to translate rather difficult legal concepts into easily understandable questions, which is not always straightforward. Moreover, respondents from the selected target groups are often not fluent in the national language of the relevant country, and may have low levels of education and short periods of residency, which means they are often unfamiliar with the cultural context of terms used in the pre-test questionnaire and therefore have difficulties in understanding some specific questions.

The findings from the pre-test suggested that more emphasis should be placed on trying to address the first of these challenges (the translation of theoretical concepts into questions), while considerable work had already been accomplished on the second. The recommendations from the cognitive pre-test study aimed to simplify questions to make them more accessible to the survey's target audience, while at the same time ensuring that definitions remain accurate and questions deliver the detailed information required. The findings and recommendations of the cognitive pre-test provided a solid basis for the further revision of the survey questionnaire, with a view to finalising it for use in the full-scale survey in all 28 EU Member States.

Based on the results of the pre-test study and other inputs, including those received through the expert consultations, FRA launched an open call for tender in 2014 to select the contractor for the full-scale survey covering the 28 EU Member States. Many of the key parameters

¹¹ Groves, R. M., Fowler, F. J., Couper, M., Lepkowski, J. M., Singer, E., and Tourangeau, R. developed this framework. See Groves *et al.* (2009).

of the survey were fixed by FRA in the technical specifications of the call for tender, such as target groups to be surveyed per country and minimum net sample size(s).

1.3. EU-MIDIS II target groups

The target groups in EU-MIDIS II varied by country. Details are in Chapter 4 on sampling. They include:

- immigrants and descendants of immigrants from North Africa;
- immigrants and descendants of immigrants from Turkey;
- immigrants and descendants of immigrants from Sub-Saharan Africa;
- immigrants and descendants of immigrants from Asia and South Asia;

- recent immigrants;
- Roma;
- members of the Russian minority.

Figure 1.1 lists the target groups of EU-MIDIS II by country.

The selection of the target groups is based on a combination of several considerations. First, the EU-MIDIS II survey aimed at a comparative EU-wide survey design, which implies inclusion and coverage of all 28 EU Member States. Second, some of the target groups in EU-MIDIS II had to be the same as the groups interviewed in the first EU-MIDIS survey (2008) to allow for trend analysis and comparison of results between survey waves. At the same time, new target groups are included in EU-MIDIS II to be able to respond to the increasing diversification of European societies and emerging vulnerabilities. Third, as in the first EU-MIDIS survey, FRA asked the competent equality bodies in each Member

Figure 1.1: Overview of target groups in EU-MIDIS II by EU Member State

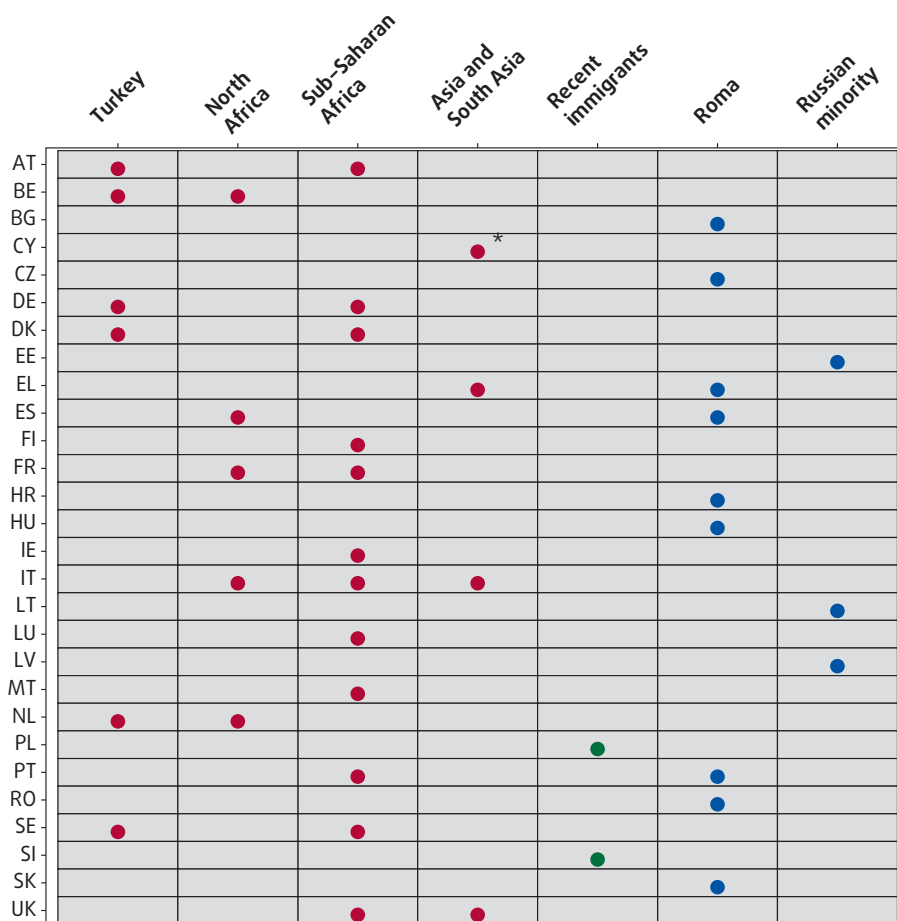

Note: * Cyprus covered only immigrants and descendants of immigrants from Asia, excluding those from South Asia.

Source: FRA, EU-MIDIS II 2016

State to identify the most common grounds of discrimination and the persons/groups most vulnerable to or at risk of discriminatory treatment and criminal victimisation, also including potentially 'racially', 'ethnically' or 'religiously' motivated discrimination and victimisation. Fourth, EU-MIDIS II takes into consideration the size of the immigrant and ethnic minority groups in each EU Member State, as well as the particular situation in each Member State with respect to its history of past and recent immigration and settlement. Furthermore, it was important to define the survey's target population in a way that maximises the possibilities for comparative analysis and examining the results for the same group in different countries, to the extent possible. Finally, the resources available for the survey, in combination with the above criteria, also served to determine the number of groups to be interviewed in each EU Member State.

1.4. Project management

FRA managed the survey in close cooperation with the contractor, Ipsos MORI. Ipsos MORI's Central Coordination Team was responsible for the coordination and management of the implementation of the fieldwork in the 28 EU Member States. The Central Coordination Team was made up of professionals from the Ipsos MORI Social Research Institute (ISRI), all of whom have extensive experience in delivering large, multi-country studies. The Central Coordination Team was led by a project coordinator, who was supported by a project manager, a sampling director and a sampling manager. The Ipsos MORI team took the lead in all local (national) subcontractor liaison and data quality management to ensure that EU-MIDIS II was delivered with maximum consistency and quality standards across the surveyed countries. Two external academic experts supported the core team of Ipsos MORI. Peter Lynn (University of Essex) was the Senior Sampling and Weighting Expert and provided critical review of the sample and weighting designs. Anthony Heath (University of Manchester) was the Senior Survey Expert providing input into the questionnaire design and training material. Due to the large number of countries included in EU-MIDIS II, Ipsos MORI assigned four 'hub' coordination managers to facilitate communication between the Central Coordination Team and the country teams. Each hub

manager was responsible for day-to-day correspondence between Ipsos MORI and seven local contractors.

FRA worked closely with Ipsos MORI, building on FRA's prior experiences with implementing EU-wide surveys on hard-to-reach groups. FRA was supported by the sampling and weighting expert Vijay Verma in the capacity of a sub-contracted external expert. Following the first expert meeting to discuss the development of EU-MIDIS II in March 2014, Vijay Verma supported FRA in the assessment of the contractor's initial sampling design and provided a critical evaluation of the overall sampling plan and the country-specific sampling approaches, together with a number of suggestions for their further improvement. His advice regarding further sampling-related information that should be collected was very helpful for the development and finalisation of the weighting procedure.

The national fieldwork partners (local subcontractors) in the 28 EU Member States comprised both local Ipsos MORI offices and third-party agencies from Ipsos MORI's wider network. (For a list of agencies see [Annex 2](#)). In Ireland and the Netherlands, the local contractor originally selected for the project had to be changed in the course of the survey implementation. In Ireland, the original network partner informed the Ipsos central team that it would not have the capacity to conduct the fieldwork in accordance with the original timetable. An alternative partner had to be appointed. In the Netherlands, concerns were raised about the quality of the work of the originally appointed subcontractor, during and after the pilot. Ipsos MORI decided to seek another supplier. It appointed Labyrinth to conduct EU-MIDIS II in the Netherlands in November 2015. In both cases, the appropriate documents were provided to FRA to allow a formal contract amendment to be made.

A quality assurance plan was agreed with Ipsos MORI at the beginning of the project. This outlined the procedures that would be used to monitor quality at all stages of the survey life cycle, and detailed how their achievement would be documented. The quality assurance plan in [Annex 3](#) of this report, and the relevant sections of the report, describe the quality assurance procedures relevant to various activities, such as sampling, translations and interviewing.

2

Development and translation of fieldwork material and survey tools

This chapter presents the main activities related to development and translation of the EU-MIDIS II survey questionnaire – the main data collection tool – and other fieldwork material. For the EU-MIDIS II survey, the following fieldwork materials were developed and used:

- EU-MIDIS II survey questionnaire, which was implemented by means of face-to-face interviewing using computer-assisted in-person interviewing (CAPI) in all the survey countries;
- a paper questionnaire in the national language(s) used in the interview, for use in exceptional cases such as if technical problems arose with the CAPI system, or when using CAPI was not possible for other reasons – mainly security concerns in some selected primary selection units, e.g. in Portugal;
- paper versions of the questionnaire in selected languages – mostly other than the national language – to facilitate communication between the interviewer and the respondent, where relevant and possible; these translations of the questionnaire into selected languages are also referred to as respondent-friendly questionnaires;
- showcards for interviewers and respondents to use during the interview; for each question where showcards were used, the cards list the answer categories relevant for that question;
- contact sheets for screening respondents for eligibility to take part in the survey, and for fieldwork monitoring;
- a training manual for interviewers;

- an introductory letter to help interviewers introduce the survey to potential respondents;
- an information postcard about the survey.

2.1. Questionnaire development

The EU-MIDIS II questionnaire was developed by FRA and finalised in close cooperation with Ipsos MORI. The questionnaire development took into account experiences of FRA's earlier surveys – most importantly the first EU-MIDIS survey and the 2011 Roma survey – as well as inputs collected in the expert consultations and the results of the pre-test. (For more details about the pre-test, see [Chapter 1](#)). The final review of the questionnaire was done based on the results of the pilot surveys in all 28 EU Member States. (For the details on the pilots see [Chapter 5 – Piloting](#)). The final English-language questionnaire (master version used to produce the translated versions) is available on the FRA website.

The final questionnaire consists of ten sections, as illustrated in [Table 2.1](#). Full details concerning the questions asked can be found by consulting the survey questionnaire.

All respondents were asked the first eight sections, from Introduction to Socio-economic background. Some questions within these sections were relevant only for specific respondent groups such as Roma, or immigrants and descendants of immigrants, e.g. residence status or family reunification. Questions in the section on Location sampling information were asked only in countries where location sampling was applied. (For

Table 2.1: Overview of EU-MIDIS II questionnaire structure

Section	Topics covered
Introduction	<ul style="list-style-type: none"> • Household information (household grid) • Child information grid • Housing and living standards
Rights awareness, perceptions and attitudes	<ul style="list-style-type: none"> • Level of attachment to various areas, e.g. neighbourhood, city, country or EU • Self-identification dimensions • Prevalence of discrimination • Awareness of support organisations, equality bodies, existing antidiscrimination legislation, recent antidiscrimination campaigns in the relevant country • Worry about being discriminated against when out in public • Avoidance behaviour
Employment	<ul style="list-style-type: none"> • Employment situation • Experiences of discrimination on any ground, and specifically related to ethnic or immigrant background when looking for work and at work • Reporting of the last incident of discrimination to any organisation • Level of satisfaction with the way the complaint was handled • Reasons for not reporting an incident of discrimination
Experience of discrimination in the following areas: <ul style="list-style-type: none"> • Health • Housing • Education • Other services 	<ul style="list-style-type: none"> • Subjective assessment of own health condition • Unmet medical care needs • Highest level of education attained • Discrimination experiences while using health care services, when trying to rent or buy an apartment or a house, or when in contact with school authorities • Discrimination experiences while using various other services such as entering a bar or a restaurant, a shop; at administrative offices or public services; in public transport • Reporting of the last incident of discrimination to any organisation • Level of satisfaction with the way the complaint was handled • Reasons for not reporting an incident of discrimination • Awareness of discrimination experiences among friends and family
Corruption experiences Police stops experiences	<ul style="list-style-type: none"> • Expectations to pay a bribe • The governmental official involved • Police stops experience in different situations • Reasons for being stopped • Level of police respectfulness • Prevalence of physical assault by the police • Reasons for not reporting an incident of physical assault by the police
Victimisation: experiences of harassment and violence	<ul style="list-style-type: none"> • Prevalence of harassment and victimisation incidents • Characteristics of the last incident: forms, frequency, perpetrators, reporting, and reasons for non-reporting, satisfaction with handling of complaint by police
Societal participation	<ul style="list-style-type: none"> • Residence status, family reunification • Application for country citizenship • Migration and mobility • Level of religiosity, wearing religious symbols • Political and civic participation • Group relations, collective identities
Socio-economic background	<ul style="list-style-type: none"> • Marital status • Household income • Support received by the household • Monetary remittances • Making ends meet • Household possessions • Prevalence of household members going to bed hungry



Section	Topics covered
Location sampling information	Frequency of visiting various locations in the city/town/village
Interviewer questionnaire	Interviewer's observations concerning the setting of the interview (e.g. presence of other people, language of the interview and respondent's fluency, interest in the topics of the interview)

Source: FRA, EU-MIDIS II 2016

more details concerning location sampling see [Chapter 4 – Sampling](#)). The interviewer filled in an interviewer questionnaire after each completed interview. It includes the interviewer's assessment of the characteristics of the interview.

Some of the answer categories and terms in the questionnaire were tailored either according to the target group or country. A generic term 'ethnic or immigrant background' was used throughout the questionnaire to address different target groups. It was changed to 'Roma' when interviewing self-identified Roma respondents in Bulgaria, Croatia, the Czech Republic, Hungary, Greece, Portugal, Romania, Slovakia and Spain. When the interview involved Russian respondents in Estonia, Latvia and Lithuania, it was replaced with 'ethnic minority background'. The interviews with immigrants and descendants of immigrants used 'ethnic or immigrant background'.

Furthermore, specific answer categories were tailored to reflect the categories relevant to each country. Examples include questions concerning the level of education achieved, income, ability to meet unexpected but necessary expenses, and references to the national equality bodies. The contractor sought expert advice during the development of the questionnaire about how to measure education across countries.

The International Standard Classification of Education (ISCED) 2011¹² categories were used to record the highest level of education gained by respondents. The National Survey Experts provided the country-specific categories for use in their respective countries, along with an explanation of how to map these categories back into the harmonised ISCED coding frame to be used for the comparative analysis. Immigrants and descendants of immigrants were also asked about the highest level of education they had achieved in a country other than the one in which they currently reside. Given the potentially large number of countries where people may have obtained their qualifications, it was not possible to provide country-specific categories for every possible country, including immigrants' countries of origin, migration and residence. Generic categories were developed, based on ISCED 2011 categories, to capture

the highest level of education that immigrants might have obtained outside the survey country.

Standardised income bands were used across all countries. The original coding frame was taken from the questionnaire used for the fifth wave of the European Working Conditions Survey, which Eurofound conducted in 2010.¹³ This was Eurofound's most recently published European Working Conditions Survey when the EU-MIDIS II questionnaire was developed. To account for the lower levels of average income among immigrants and ethnic minorities in some EU Member States, two additional income bands were added to the lower end of the scale. The original scale was in euros, and for countries outside the Eurozone the exchange rate from the European Central Bank on 12 May 2015 was used to convert the income bands into national currencies. To allow comparability in the final dataset, information that the respondents provided in national currencies was converted back to euro equivalents using the same exchange rate.

For the question measuring whether a household could afford an unexpected but necessary expense the amount specified was set at 1/12 of the national at-risk-of-poverty threshold for a one-person household in 2013.¹⁴

To measure awareness of equality bodies in each country, a list of up to three relevant bodies in each country was used. The list included only those bodies with which an individual can lodge a complaint after experiencing discrimination.

A range of different CAPI software programmes were used for the data collection. In nine survey countries, the same software was used with the contractor scripting the questionnaire centrally. The master script was then overlaid with the translated versions of the questionnaire. In the other 19 survey countries, 11 different CAPI software programmes were used for scripting and data collection. In all of these cases, the questionnaire was scripted locally following the filtering and routing instructions provided in the master questionnaire, and the scripting was checked by Ipsos MORI.

¹² For further information concerning ISCED see the Commission's [webpage on ISCED](#).

¹³ Eurofound (2010).

¹⁴ Eurostat (2016).

2.2. Questionnaire translation

The English master version of the EU-MIDIS II survey questionnaire was translated into 22 EU languages as well as into Arabic, Kurdish, Russian, Somali, Tamazight and Turkish. The translations largely followed the scheme outlined in FRA's technical specifications for the survey. In addition to the language versions originally requested by FRA, the decision was made to translate the questionnaire into Kurdish, based on feedback from local contractors interviewing immigrants and descendants of immigrants from Turkey. Furthermore, a translation into Tamazight was produced for use in the Netherlands, based on pilot results indicating that a large proportion of the North African target group spoke this language. Table 2.2 at the end of this chapter presents an overview of the various survey tools and the translations produced. The questionnaire translation procedure followed the TRAPD (Translation, Review, Adjudication, Pre-test and Documentation) model as illustrated in Figure 2.1. Ipsos MORI subcontracted cApStAn – an agency specialised in translatability assessments – and cApStAn's sister agency BranTra to translate the questionnaire and some of the non-EU language material.

A team of translators produced each language version of the questionnaire. The team consisted of two linguists, who each produced independently an original translation of the source questionnaire (Translation 1 and Translation 2), and one adjudicator responsible for merging and adjudication of the two translations. Translator 1 (T1) and the adjudicator were appointed by cApStAn while Translator 2 (T2) was appointed by the local fieldwork sub-contractor. Web-based training seminars were organised by BranTra/cApStAn both for the translators and for the adjudicators before the start of the translation activities.

In preparation for translation, FRA and Ipsos MORI prepared a list of key terms to be used in the survey. The list included a glossary compiled by FRA with definitions of key terms and their translations in various languages.

It also included the names of equality bodies referred to in the questionnaire, compulsory school age across the survey countries, and the name and definition of each target group.

The EU-MIDIS II questionnaire included three questions regarding respondents' assessment of their overall health, which were taken from the European Health Interview Survey¹⁵ coordinated by Eurostat. Available translations were applied for the EU-MIDIS II survey, except in Spain, where the translations from the EU-SILC survey (Statistics on Income and Living Conditions)¹⁶ were used. The three questions on overall health status are also referred to as the Minimum European Health Module, which Eurostat includes in relevant EU surveys.

The following convention to gender neutrality in multi-lingual surveys was adopted for the translation of the EU-MIDIS II survey questionnaire. If gender was differentiated in the source questionnaire (e.g. "he/she..." or "his/her..."), translators and adjudicator were instructed to also differentiate if applicable in the relevant language, and to insert a comment if local usage deviates from the master version in this respect. If gender was not differentiated in the source questionnaire but two forms were possible or necessary in the translated version (e.g. in "are you satisfied?" – in some languages "are" + "you" + "satisfied" might each have a masculine and a feminine form), translators and adjudicators were instructed to adopt the most neutral/common form and to avoid double gender, slashes and repetition of words, and to include instructions to the interviewers to use the appropriate form when addressing the respondent.

The same questionnaire translation process was applied for each of the languages, except for Tamazight, for which the initial translation was undertaken by an experienced linguist and then verified by two independent linguists.¹⁷ All three translators agreed that they should use common vocabulary that a range of Berber-speaking respondents could understand, regardless of which country they are from. The questionnaire translation process for the other languages proceeded as follows.

¹⁵ Eurostat (2017a).

¹⁶ Eurostat (2017b).

¹⁷ The need for including Tamazight was raised later and therefore a different procedure had to be followed.



Figure 2.1: Illustration of TRAPD (Translation, Review, Adjudication, Pre-test and Documentation) translation procedure used in translating the EU-MIDIS II questionnaire

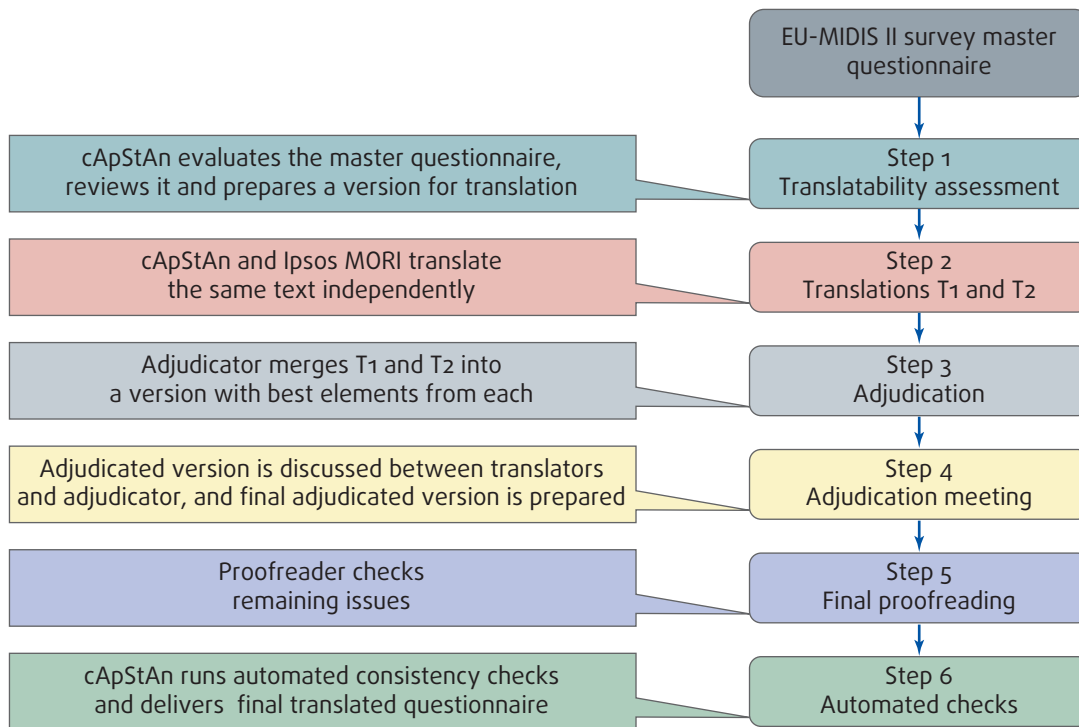

Source: FRA, EU-MIDIS II 2016

Step 1. Translatability assessment

Prior to the full translation, a translatability assessment was undertaken based on the master questionnaire. A translatability assessment contributes to making the source material fit for translation and may raise awareness of potential hurdles that should be taken into account when finalising the master questionnaire, in view of adaptations that would be needed to make translating the questions into certain languages more accurate.

A pool of experienced linguists, representing various language groups, received a selection of survey questions from the master questionnaire. They assessed the questions for Slavic languages (Croatian, Czech, Polish and Russian), Germanic languages (Danish, German and Swedish) and Romance languages (French, Italian and Romanian), as well as for Greek and Latvian. They also assessed a sample of questions in Arabic and Turkish. The linguists produced advance translations to identify issues that would confront translators. The results were presented in a translatability report, in which special attention was given to items for which at least two linguists identified problems, and to issues that were likely to apply to other languages, providing suggestions for alternate wording or notes for translators to circumvent the detected issue.

Both during translation and adjudication/adaptation, BranTra/cApStAn set up a helpdesk which provided advice and answered questions and queries from translators and adjudicators.

Step 2. Two translations prepared in parallel

As a general rule, one translator (T1) translated the entire text, while the other translator (T2) translated only segments selected for parallel translation.

Step 3. Adjudication

The two translations were collated and then provided to the adjudicator whose task was to produce a reconciled version while ensuring consistency in the use of terms across the questionnaire. The adjudicator's comments and problems faced when having to reconcile between the translations served as a basis for discussion during the adjudication and/or team review meeting.

Step 4. Adjudication meeting

The meeting brought together the translation team members to discuss the outcome of the translation and adjudication process, issues raised, and solutions proposed for the final review. Each translation team discussed issues earmarked for discussion one by one, and the adjudicator took the outcomes of the adjudication

meeting into account when preparing the final version of the translation.

Some language versions were shared by two or more countries in the survey – for example, the questionnaire in French was used in France, Belgium and Luxembourg. In this case teams in each country appointed adaptors who assessed the translation to highlight cases where the translation needed to be adjusted to account for local dialect or typical terms used which may differ between countries. For language versions that were shared by two or more countries in the survey, the adaptors were also invited to the team review meeting. Their role was to contribute to the discussion, to point out differences for their adapted version (e.g. different German terms or expressions used in Austria and Germany), but also to ensure that remaining errors spotted by each adaptor would be corrected in all versions of that language, if applicable.

Step 5. Final proofreading

The proofreader's role was to check that the final version of the translation was correct, without reference to the master questionnaire. This final step covered spelling, grammar, syntax and completeness. The proofreader was also to double-check that the translated version had corrected errata.

Step 6. Automated checks

Using automated quality assurance routines, the proofread translated version of the questionnaire was double-checked with regard to completeness of the translation (such as checking that the number of answer categories is the same in the master questionnaire and the translation) and consistency in translation of agreed key terms.

The translation process was documented and archived using a centralised monitoring tool which reflected each step of the process. FRA was able to monitor the process and its progress.

In a final step, FRA staff members reviewed the language versions of the questionnaire for those languages in which they were fluent. Overall, FRA's in-house experts were able to proofread most translations.

2.3. Development and translation of other survey material

Besides the questionnaire, a number of EU-MIDIS II documents were produced to aid the implementation of the survey. Ipsos MORI provided the first draft of these

fieldwork documents, and FRA provided comments and signed off on the final versions. All interviewer and respondent related material were translated into the relevant languages used in administering the survey. Some documents were only required in the 22 national languages as they were only to be used by the interviewers (e.g. interviewer instructions, contact sheets or training manual) while other fieldwork documents were required in additional languages as they were meant for the respondents with the aim of increasing participation (e.g. introductory letters) or aid completion of the interview (e.g. showcards). For this material a simplified approach to translation was adopted consisting of single translation and proof reading by two separate linguists. All translated survey material were approved by FRA before the mainstage fieldwork.

Respondent-friendly paper version questionnaires

The questionnaire was translated for CAPI scripting into 22 EU languages plus Russian, Somali, Tamazight and Turkish. CAPI scripting was not available in Arabic and Kurdish – instead a paper questionnaire was prepared in these two languages. In addition to CAPI scripting, in some countries and languages a so called respondent-friendly paper version of the questionnaire was prepared (see Table 2.2). These versions were modified to allow the respondents to follow the questions as the interviewers read them in the national or another survey languages. This was developed as a way of assisting respondents who may have problems in understanding the survey questions in the language used in the interviews. Interviewer instructions and routing instructions as well as all answer categories which were not meant to be read out by the interviewer had been removed from this paper questionnaire to avoid confusion.

Showcards

Showcards were based on the approved questionnaire translations. For some questions the order of the codes on the showcards were presented in standard (e.g. answer categories listed from A to E) and reverse order (e.g. from E to A) to help mitigate any effect which the order of the categories may introduce into respondents answers. Each pack of showcards included only one version – either standard or reverse – and interviewers were given one or the other to use for all of their interviews.

Contact sheets

The use of contact sheets was a vital part of the sampling procedure in those countries where sampling could not be based on a national population register of individuals. The interviewers used the contact sheet to collect the necessary information when applying



different sampling methods across the survey countries. The contact sheets were country-tailored and adapted with regard to the target group and the sampling method(s) applied in each country. For example, questions in the contact sheet related to self-identification of respondents were adapted to take into account whether the interviewer was screening for Roma or Russian minority respondents, as opposed to immigrants and descendants of immigrants. Interviewers also recorded details concerning the sampling approaches used, such as using address registers, random walk, location sampling or other methods, as instructed by the fieldwork management team. In total, 13 versions of the contact sheet were developed and used in the fieldwork in different countries.

Interviewer training manual

The training manual was the main reference for the interviewer training session, and it was designed as a resource for the interviewers during fieldwork. The manual covered a wide range of topics, such as:

- background and aims of the EU-MIDIS II survey;
- sampling method for each country and/or target group;

- how to make contact with and select respondents for interview;
- advice on how to introduce the survey and maximise response rates;
- administration of the survey material;
- ethical, cultural and safety considerations.

Country versions of the training manual were tailored as necessary, in accordance with the sampling method implemented and target group(s) selected.

Introductory letter and postcard

Following consultations with the National Survey Experts and feedback from the pilot, the introductory letter with information about the survey was translated into six further languages (Hindi, Tagalog, Tamazight, Tigrinya, Urdu, and Vietnamese) in addition to the other languages being used to administer the survey. A postcard with information about the survey was available in all national languages. Both the introductory letter and the postcard were shared with the respondents to promote the importance of the survey and ensure positive contact with potential respondents. Both letter and postcard also provided contact details in case of any queries about the survey.

Table 2.2: Overview of EU-MIDIS II survey material and translations produced

Country	Questionnaire CAPI script and showcards	Respondent-friendly paper version of the questionnaire	Interviewer training manual and contact sheets	Introductory letter	Postcard
AT	German, Turkish	Somali, English, Turkish, French	German	German, Turkish, Somali	German
BE	French, Dutch	Arabic, Turkish, Kurdish	French, Dutch	French, Dutch, Arabic, Turkish	French, Dutch
BG	Bulgarian		Bulgarian	Bulgarian	Bulgarian
CY	Greek, English	Greek, English	Greek	Greek, English, Tagalog	Greek
CZ	Czech		Czech	Czech	Czech
DE	German	French, Turkish, Kurdish, English	German	German, French, Turkish, Kurdish, English,	German
DK	Danish, Turkish, Somali	Turkish, Somali, Kurdish	Danish	Danish, Turkish, Kurdish, Somali	Danish
EE	Russian		Estonian	Russian	Russian
EL	Greek, English	English	Greek	Greek, English	Greek
ES	Spanish	French	Spanish	Spanish, Arabic, French	Spanish
FI	Finnish	Somali	Finnish	Finnish, Somali	Finnish
FR	French		French	French, Arabic, Tigrinya	French
HR	Croatian		Croatian	Croatian	Croatian
HU	Hungarian		Hungarian	Hungarian	Hungarian
IE	English	Somali	English	English, Somali	English
IT	Italian	English, French, Arabic	Italian	Italian, English, French, Arabic	Italian
LT	Lithuanian, Russian		Lithuanian	Lithuanian, Russian	Lithuanian, Russian
LU	French, Portuguese, English	French, Portuguese, English	French	French, English, Portuguese	French
LV	Latvian, Russian		Latvian	Latvian, Russian	Latvian
MT	Maltese, English		English	Maltese, English, Somali, French, Arabic	Maltese, English
NL	Dutch, Tamazight	Arabic, Turkish, Kurdish, Tamazight	Dutch	Dutch, Arabic, Turkish, Kurdish, Tamazight	Dutch
PL	Polish	Russian, English	Polish	Polish, Russian, English, Vietnamese	Polish
PT	Portuguese		Portuguese	Portuguese	Portuguese
RO	Romanian		Romanian	Romanian	Romanian
SE	Swedish	English, Kurdish	Swedish	Swedish, English	Swedish
SI	Slovenian		Slovenian	Slovenian	Slovenian
SK	Slovakian		Slovakian	Slovakian	Slovakian
UK	English	Somali	English	English, Hindi, Somali, Urdu	English

Source: FRA, EU-MIDIS II 2016

3

Interviewer selection and training

The complexity of the survey related to interviewing immigrants and ethnic minorities from diverse backgrounds across the EU-28, as well as to developing sampling designs and field work methods. This required teams in each country to be very well informed about fieldwork procedures and the roles of country team members in the data collection process. To ensure the quality of data collection, FRA's project specifications set out detailed requirements both for training of the National Survey Experts and the interviewers in each country, and FRA took part in these training events to monitor the implementation of training activities and to note questions raised during these events so that it could assess the need for final adjustments to the survey methodology before the start of the full-scale data collection stage.

3.1. Central project briefing

A two-day central briefing for the National Survey Experts (NSEs) representing the local subcontractors in 27 EU Member States took place in Berlin at the beginning of June 2015.¹⁸ To ensure that ample attention was paid to the particular target groups and the different sampling methodologies, the briefings took place over two sessions (each two days), with those surveying Roma and Russians being briefed separately from countries where only immigrants and descendants of immigrants were to be interviewed.

The briefing covered the following topics:

- a) introduction to the project objectives, main requirements and content, and an overview of the

¹⁸ The Irish agency and the replacement agency in the Netherlands were exceptions; they joined the project later and were briefed separately.

- b) detailed definitions of the target groups, with particular focus on how eligibility to participate in the survey needs to be established;
- c) the sampling approaches – random route sampling as well as the adaptive cluster sampling (for those countries implementing this method);
- d) practising and testing use of the contact sheets (forms to be filled in by interviewers when screening potential respondents for eligibility);
- e) other issues relevant to the fieldwork, such as use of introductory letters, how to convince potential respondents of the importance of taking part in the survey, tools available to assist respondents with limited language skills, and issues related to potentially different cultural practices among respondents that the interviewers should be aware of;
- f) gaining cooperation from local non-governmental organisations or community leaders to help gain access to surveyed target populations (relevant primarily to Roma);
- g) detailed description of the questionnaire and its administration;
- h) quality control measures;
- i) interviewer training.

3.2. Interviewer selection and training

Due to the complex nature of the survey, all interviewers were required to have prior experience of working on surveys that used probability sampling. Where possible, National Survey Experts were instructed to select interviewers with experience of interviewing

respondents about sensitive topics to work on the survey. To maximise participation and response rates in the survey, countries were also asked to facilitate interviewer matching with regard to ethnicity and gender where possible. Some countries were able to do this more easily than others were, depending on the availability of suitable interviewers. For example, during the pilot the team in Denmark found that having Turkish speaking interviewers significantly increased the likelihood of securing respondents' participation, and consequently the team increased its pool of Turkish-speaking interviewers. However, not all countries were able to change the composition of their interviewing teams, and some countries that did so found that the changes did not always translate into improved response rates. For example, the United Kingdom found that Sub-Saharan African or South Asian interviewers were not always more successful than their white British colleagues, and that the interviewer's polling experience was a much more important factor. Belgium noted the same issue. These considerations, alongside guidance concerning the maximum workload per interviewer, determined which interviewers to select.

Table 3.1 presents details of the number of interviewers who were trained to work on EU-MIDIS II, and interviewer training sessions. In three of the nine EU Member States where Roma were surveyed, interviewers identifying themselves as Roma were included among the field force. In the other six countries where EU-MIDIS II interviewed Roma, interviewers with Roma background who had the requested experience were not available.

All interviewers were required to attend a two-day training. In most countries more than one training session was organised, for example to train interviewers working in different parts of the country. The training was particularly important for countries using new or more complex sampling methodology (such as random route, adaptive cluster sampling or location sampling). The interviewer training sessions followed a similar structure as the central briefing, and the National Survey Experts were instructed to tailor and translate the centrally produced material for use in their trainings to reflect their country specifics.

The National Survey Experts were advised to pay particular attention to rules concerning the respondent eligibility criteria and sampling, completion of the contact sheet, the questionnaire and fieldwork logistics. NSEs were also advised to periodically remind interviewers to apply consistently the quality control measures, and to share good practice examples – especially from those interviewers who earlier had carried out the pilot interviews, which took place before the main interviewer training sessions. Teams were encouraged to make their training sessions as interactive as possible, using the centrally produced exercises and role play material.

In the countries where Roma were to be surveyed, the NSEs were also encouraged to invite representatives from non-governmental organisations working with Roma to attend the briefings so that they could share their practical insights about the target group.¹⁹

Where possible, members of the FRA team attended the training sessions, and upon request provided clarifications directly to the local teams as necessary regarding the fieldwork implementation and rationale of the survey questions. FRA also provided feedback about how the briefing sessions could be further improved, and Ipsos MORI communicated FRA's feedback to the local sub-contractor in question and other countries where relevant.

For some countries, it was necessary to hold additional briefings to those originally foreseen. Reasons for this included:

- There was sometimes a gap between the initial briefing and the fieldwork starting date. This often resulted from unforeseen circumstances such as a delay in receiving the sample, or due to having to delay fieldwork due to other reasons such as overlap with national or local elections. In these instances, countries were asked to conduct refresher trainings.
- It was sometimes necessary to recruit new interviewers to the project. This was often because interviewers were working on other projects in parallel with the FRA survey, which meant that additional interviewers had to be recruited and trained to ensure that there was an adequate number of interviewers to complete the project. Some interviewers also decided to leave the project; reasons for this were often specific to the country and context.²⁰

¹⁹ For example, in Bulgaria, two Roma organisations – World Without Borders and Amalipe – attended the central training. In Denmark, one member of a community organisation in Aarhus, which helped the interviewers to gain access to the Sub-Saharan African target group, also attended the interviewer training in Aarhus. In Spain, members of the NGO Fundación Secretariado Gitano attended the interviewer training to give advice and answer interviewers' questions.

²⁰ For example, interviewers in Belgium and France were increasingly hesitant to work in certain areas after the terrorist attacks in 2015 and 2016. Interviewers from some other countries (including the Netherlands) found the project challenging, and preferred to work on other surveys where it was easier to recruit respondents. However, adequate safeguards were implemented on time and the sampling was therefore not affected. For example, when sampling the PSUs, a replacement PSU was drawn for each PSU in the sample following the same randomization principles as in the original sample. Therefore, when the fieldwork could not be done in certain areas (PSUs) the replacement PSU was used for the interviewing. In this way the representativity of the sample was not compromised.



Table 3.1: Number of interviewers trained to work on EU-MIDIS II and dates of interviewer training sessions

Country	Total number of interviewers briefed	Dates of interviewer training sessions
AT	31	16-17*, 23-24 October 2015; 14-19 November 2015
BE	72	12-13*, 22-23, 26-27 October 2015; 5-6, 18-19, 21-22 November 2015; 3 and 5 December 2015; 25 February 2016
BG	64	19-20*, 26-27 October 2015
CY	19	6-7 October 2015; 25-26 February 2016
CZ	54	6-7, 8-9*, 10-11, 12-13 October 2015; 14-15 January 2016
DE	87	1-2*, 7-8 October 2015
DK	56	29 September 2015; 1 October 2015; 2 and 5 December 2015; 13, 15 and 26 January 2016; 10 March 2016; 5 and 27 April 2016; 7 May 2016
EE	35	2-3*, 9-10 October 2015
EL	36	25-26 September 2015*; 6-7, 9-10, 11-12 November 2015
ES	54	22-23 September 2015*; 30 October 2015; 2-6, 13-14, 24-27 November 2015
FI	23	22-23*, 24-25 September 2015; 5-6 November 2015
FR	87	13-14*, 20-21, 22-23 October 2015
HR	29	1-2*, 10-11 October 2015; 5-6 November 2015; 1 February 2016
HU	51	29-30 September 2015; 21 October 2015; 1 February 2016
IE	15	13-14 October 2015*; 4 interviewers received separate, one-to-one training; refresher briefing in March 2016
IT	72	30 September and 1 October 2015*; 6-7, 8-9, 13-14 October 2015; 1-2 February 2016
LT	30	28-29 September 2015*; 25-26 November 2015
LU	18	14-15 March 2016; refresher training 6-7 April 2016
LV	16	28-29 October 2015
MT	15	17-18 November 2015
NL	54	26-27 November 2015; 8 January 2016; 4-5 April 2016; 12-13, 24-25 May 2016
PL	16	22-23 September 2015*; 27 November 2015; 4-5 February 2016
PT	20	13-14 October 2015*; 15 November 2015; 5 January 2016
RO	80	17-18 September 2015*; 5-6, 12-13, 14-15 October 2015
SE	25	3-4 November 2015*; January 2016
SI	29	24-25, 26-27 November 2015; 3-4 December 2015; 15-16 January 2016
SK	75	25-26, 27-28 September 2015; 2-3, 4-5 October 2015; 4-5 January 2016
UK	78	15-16*, 21-22, 28-29 September 2015; 30-1 October 2015; 24-25 November 2015

Note: * Training attended by FRA.

Source: FRA, EU-MIDIS II 2016

4

Sampling

The survey set out to achieve a random probability sample of each selected target group in the respective EU Member States; to provide survey results that would be representative for the target populations with immigrant or ethnic background in each country; and to allow comparison between countries. The groups covered in the survey are not covered or are insufficiently covered in the comparative general population surveys of the European statistical system. The range of available survey and sampling methodologies has increased enormously in recent decades. However, reliable strategies for obtaining probability samples for elusive and/or hard-to-reach populations, such as immigrants and ethnic minorities, are still rare. The survey built on the sampling approaches and experiences gained in previous FRA surveys – in particular the first EU-MIDIS survey in 2008 and the Roma survey in 2011 – to further refine sampling methodologies and increase the efficiency of selected sampling approaches. However, in the absence of a sampling frame in a number of countries, statistical assumptions were made following close cooperation with Professor Vijay Verma (University of Siena), the external senior survey and sampling expert on elusive populations.

Due to the heterogeneity of the target groups in EU-MIDIS II and different circumstances in the countries, a combination of different sampling approaches was applied. The development of the sampling approaches started with a mapping exercise to identify the most appropriate sample frames to sample the target groups. After establishing an overview of the various options, FRA and Ipsos MORI developed sampling plans appropriate to the situation of each country and target group, and best able to meet the requirements of the survey using the available resources. The sample sizes were also optimised for each target group across countries,

taking into account the relative sizes of the populations and sample design quality.

This chapter describes the various steps and approaches to sampling employed in EU-MIDIS II. It begins with a detailed definition of the target groups of the survey, followed by a description of sample frames, and planned and implemented samples across countries and groups. Furthermore, it provides information on the outcome of the mapping exercise, and outlines the sampling approaches used and how it was implemented in the field.

4.1. Target populations and sample requirements

The survey sampled individuals aged 16 years and older:

- who self-define as persons of immigrant or ethnic minority background; this includes immigrants, descendants of immigrants, as well as ethnic minorities (including Roma and people from the Russian minority);
- whose usual place of residence is in the EU Member State surveyed;
- who have been living in private households in the EU Member State surveyed for at least the last 12 months.²¹

²¹ In a small number of countries, persons who were not living in private households were also included in the sample. For example, in Malta, the target population (immigrants and descendants of immigrants from Sub-Saharan Africa) was very small. Without including persons living in institutional homes, the coverage of this population would have been incomplete.

The choice of target groups for EU-MIDIS II was based on a combination of criteria, including:

- size of the target group in a country;²²
- feasibility of survey, in terms of costs and accessibility;²³
- risk of ‘racially’, ‘ethnically’ or ‘religiously’ motivated discrimination and victimisation;²⁴
- vulnerability to social exclusion;²⁵ and/or
- comparability with FRA’s first EU-MIDIS survey and the 2011 Roma survey.

Finally, in combination with the above criteria, the resources available for the survey also served to determine the number of groups to be interviewed in each EU Member State.²⁶ However, the criteria were applied to ensure that the survey covered at least one target group in each Member State.

The term immigrants and descendants of immigrants, as well as the term ethnic minorities are used in the context of EU-MIDIS II as umbrella terms encompassing a wide range of groups and diversity of characteristics.

Immigrants and descendants of immigrants in EU-MIDIS II

Immigrants, descendants of immigrants and recent immigrants included **both citizens and non-citizens** of the survey country irrespective of their formal residence status. For the purpose of the survey, the term ‘immigrants and descendants of immigrants’ encompasses the following:

- ‘**Immigrants**’ include persons who were **not** born in an EU Member State or a European Economic Area (EEA)/European Free Trade Association (EFTA) country (Iceland, Liechtenstein, Norway and Switzerland), who had their usual place of residence in the territory of the EU Member State where the survey was conducted, and who had been living in

the survey country for at least 12 months before the interview.

- ‘**Descendants of immigrants**’ are persons who were born in one of the current 28 EU Member States or an EEA/EFTA country, whose usual place of residence was in the territory of the EU Member State where the survey was conducted, and who had at least one parent **not** born in an EU or EEA/EFTA country (Liechtenstein, Iceland, Norway and Switzerland).
- In some EU Member States, EU-MIDIS II interviewed ‘**recent immigrants**’. These are persons who immigrated to an EU Member State in the 10 years before the survey (i.e. after 2004), whose usual place of residence was in the territory of the EU Member State where the survey was conducted, and who had been living in the survey country for at least 12 months before the interview. The country of birth of ‘recent immigrants’ can be any country outside the EU-28 or an EEA/EFTA country.

EU-MIDIS II covered the following groups under the concept ‘immigrants and descendants of immigrants’:

- immigrants and descendants of immigrants from Turkey (in 6 EU Member States);
- immigrants and descendants of immigrants from North Africa (in 5 EU Member States);
- immigrants and descendants of immigrants from Sub-Saharan Africa (in 12 EU Member States);
- immigrants and descendants of immigrants from South Asia and Asia (in 4 EU Member States);
- recent immigrants from other non-EU/EFTA countries (in 2 EU Member States).

For higher efficiency in screening up to two people were interviewed in each household for the target groups ‘**immigrants and descendants of immigrants**’ and ‘**recent immigrants**’. Table 4.1 details which countries fall into each category. Table 4.2 details the group or groups interviewed in each country.

22 In some countries, it was decided to sample recent immigrants, because there was not one single particular group large enough to be surveyed. The 10-year period focuses on the period since the relevant country acceded to the EU.

23 Potential target populations, such as Roma in France and Italy, were excluded, as accessibility of halting sites and encampments was very difficult during FRA’s 2011 Roma pilot survey.

24 As identified by the national Equality Bodies.

25 In particular for the selection of countries with Roma populations.

26 For instance, Travellers in Ireland were not surveyed, due to costs and the fact that previous research had been done on the national level.



Table 4.1: Definition of country of birth, or country of birth of at least one of the parents, for target groups 'immigrants' and 'descendants of immigrants'

Target group	Country or region of birth (of the respondent or at least one of his/her parents)
Immigrants and descendants of immigrants from Turkey	Turkey
Immigrants and descendants of immigrants from North Africa	Algeria, Egypt, Libya, Morocco, Sudan, Tunisia, Western Sahara
Immigrants and descendants of immigrants from Sub-Saharan Africa*	Angola, Benin, Botswana, Burkina Faso, Burundi, Cameroon, Cape Verde, Central African Republic, Chad, Congo, Comoros, Côte d'Ivoire, Democratic Republic of the Congo, Djibouti, Equatorial Guinea, Eritrea, Ethiopia, Gabon, Ghana, Guinea, Guinea-Bissau, Kenya, Lesotho, Liberia, Madagascar, Malawi, Mali, Mauritania, Mauritius, Mayotte, Mozambique, Namibia, Niger, Nigeria, Réunion, Rwanda, Saint Helena, São Tomé and Príncipe, Senegal, Seychelles, Sierra Leone, Somalia, South Sudan, Swaziland, Tanzania, The Gambia, Togo, Uganda, Zambia, Zimbabwe. UK and France only: Anguilla, Antigua and Barbuda, Bahamas, Barbados, British Virgin Islands, Curacao, Dominica, Grenada, Guadeloupe, Haiti, Jamaica, Martinique, Montserrat, Saint Lucia, Turks & Caicos Island
Immigrants and descendants of immigrants from South Asia	Bangladesh, Bhutan, India, Maldives, Nepal, Pakistan, Sri Lanka UK only: except India
Immigrants and descendants of immigrants from Asia (Cyprus only)	Afghanistan, Armenia, Azerbaijan, Bahrain, Brunei, Cambodia, China, Hong Kong, Macao, Georgia, Indonesia, Iran, Iraq, Israel, Japan, Jordan, Kazakhstan, Kuwait, Kyrgyzstan, Laos, Lebanon, Malaysia, Mongolia, Myanmar/Burma, North Korea, Oman, Palestine, Philippines, Qatar, Saudi Arabia, Singapore, South Korea, , Syria, Tajikistan, Thailand, Timor-Leste, Turkmenistan, United Arab Emirates, Uzbekistan, Vietnam, Yemen

Note: * For the purpose of the survey, migrants from French departments such as Guadeloupe, French Guiana, Martinique, Mayotte and Réunion are included, but are strictly speaking not immigrants.

Source: FRA, EU-MIDIS II 2016

Table 4.2: EU-MIDIS II target groups by country

Country	Target group
AT	Immigrants and descendants of immigrants from Turkey Immigrants and descendants of immigrants from Sub-Saharan Africa
BE	Immigrants and descendants of immigrants from Turkey Immigrants and descendants of immigrants from North Africa
BG	Roma
CY*	Immigrants and descendants of immigrants from Asia
CZ	Roma
DE	Immigrants and descendants of immigrants from Turkey Immigrants and descendants of immigrants from Sub-Saharan Africa
DK	Immigrants and descendants of immigrants from Turkey Immigrants and descendants of immigrants from Sub-Saharan Africa
EE	Russian minority
EL	Roma Immigrants and descendants of immigrants from South Asia
ES	Roma Immigrants and descendants of immigrants from North Africa
FI	Immigrants and descendants of immigrants from Sub-Saharan Africa
FR	Immigrants and descendants of immigrants from North Africa Immigrants and descendants of immigrants from Sub-Saharan Africa
HR	Roma
HU	Roma
IE	Immigrants and descendants of immigrants from Sub-Saharan Africa
IT	Immigrants and descendants of immigrants from South Asia Immigrants and descendants of immigrants from North Africa Immigrants and descendants of immigrants from Sub-Saharan Africa
LT	Russian minority
LU	Immigrants and descendants of immigrants from Sub-Saharan Africa
LV	Russian minority
MT	Immigrants and descendants of immigrants from Sub-Saharan Africa
NL	Immigrants and descendants of immigrants from Turkey Immigrants and descendants of immigrants from North Africa
PL	Recent immigrants
PT	Roma Immigrants and descendants of immigrants from Sub-Saharan Africa
RO	Roma
SE	Immigrants and descendants of immigrants from Turkey Immigrants and descendants of immigrants from Sub-Saharan Africa
SI	Recent immigrants
SK	Roma
UK	Immigrants and descendants of immigrants from South Asia (excluding India) Immigrants and descendants of immigrants from Sub-Saharan Africa

Note: * Immigrants and descendants of immigrants from South Asian countries were excluded from the definition of the target group in Cyprus.

Source: FRA, EU-MIDIS II 2016



Ethnic minorities in EU-MIDIS II

EU-MIDIS II uses the term ‘ethnic minorities’ to refer to Roma and persons of Russian background who were interviewed for the survey.²⁷

In some EU Member States, ethnic minorities such as the Roma or the Russian minorities are recognised in law as ‘national minorities.’ Although this is not the case in all EU Member States, for the purpose of the survey, the generic term ‘ethnic minority’ was defined in the context of Roma and Russian minorities as in Table 4.3.

For the Roma and Russian ‘**ethnic minority**’ target groups, only one person per household could be interviewed. In EU-MIDIS II, Roma were interviewed in nine EU Member States, and Russian minorities in three countries. Table 4.2 presents the distribution of target groups surveyed across EU Member States.

To increase sampling efficiency and reduce screening costs, up to two people could be interviewed in each household for the target groups ‘**immigrants and descendants of immigrants**’ and ‘**recent immigrants**’. For the Roma and Russian ‘**ethnic minority**’ target groups, only one person per household could be interviewed.

4.2. Sample sizes

EU-MIDIS II achieved a total net sample size of 25,200 interviews across the 28 EU Member States. In determining the target sample sizes by country and by group, an optimal allocation of the sample was examined taking into account:

- a minimum sample size of 500 interviews per country and a minimum of 400 interviews per target group;
- the size of the target group population – within a country and overall in the EU – with the aim of maximising the efficiency of cross-country weighting.²⁸

For a given group, the sample was distributed across countries in relation to the *absolute size* of the group in the country. This procedure optimises the sample allocation across countries, but because it is important for EU-MIDIS II to also deliver results for each group at the level of individual EU Member States, the sample size was adjusted to ensure the minimum sample size of 400 interviews per group and a minimum of 500 interviews per country.

Table 4.3: Definitions of ethnic minority target groups in EU-MIDIS II

Target group	Definition
Roma	<p>The term “Roma” is used as an umbrella term in the Council of Europe definition and refers to Roma, Sinti, Kale and related groups in Europe, including Travellers and the Eastern groups (Dom and Lom). It covers the wide diversity of the groups concerned, including persons who identify themselves as Gypsies. The Council of Europe uses the term “Roma and Travellers” to encompass the wide diversity of groups covered by the work of the Council of Europe in this field: “on the one hand a) Roma, Sinti/Manush, Calé, Kaale, Romanichals, Boyash/Rudari; b) Balkan Egyptians (Egyptians and Ashkali); c) Eastern groups (Dom, Lom and Abdal); and, on the other hand, groups such as Travellers, Yenish, and the populations designated under the administrative term ‘Gens du voyage’, as well as persons who identify themselves as Gypsies.” See the Council of Europe’s webpage on Roma.</p> <p>For the purpose of this survey, the term ‘Roma’ refers to persons who self-identify as ‘Roma’ or as one of the other groups that the term ‘Roma’ covers. It refers to <i>autochthonous</i> ‘Roma’ minorities within selected EU Member States and does not encompass ‘Roma’ who have moved from to the survey country from another EU Member State or Travellers.</p>
Russian minority	<p>For the purpose of this survey, the term ‘Russian minority’ refers to persons who self-identify as belonging to a Russian national or ethnic minority in the EU Member States where this group was included in the survey. The term includes both citizens and non-citizens of the country surveyed (including persons without citizenship).</p>

Source: Council of Europe, 2012

²⁷ In practical implementation, in a few countries, residents outside private households were also included. For example, in Malta, the target population is very small and, without including some of the institutional homes, the population could not have been covered. In other countries where location sampling was applied, a clear distinction cannot always be made.

²⁸ Efficiency means to calculate the optimal sample size with the best precision for between- country comparisons and within- country estimates.

Therefore, the sample allocated to country i with size S_i of the group concerned is

$$n_i = \max(n_{\min}, kS_i^a)$$

where a is a 'compromise' parameter 0.5, and constant k is determined by the requirement that the country allocations n_i sum up to the total sample size n assigned to the group.

Further adjustments to sample sizes had to be made taking into consideration:

- the relative quality of the country-level sample designs (in particular, the population coverage and sample efficiency that could be achieved);
- the relative cost of the fieldwork in each country; and
- the heterogeneity of a group within a country, such as different countries of origin, or the need to differentiate between first- and second-generation respondents as a part of the analysis of the results.

Tables 4.4 to 4.10 present the target group population sizes, the within-target group optimal allocation range considered, the final agreed target sample sizes and the final delivered sample sizes of interviews. Two approaches defined an optimal allocation range by assessing the following: 1) the maximum possible cross-country sample efficiency, while taking into account the minimum target group sample size of 400 per country, and 2) a slightly less efficient method aimed for a compromise between overall cross-country efficiency and a more even distribution between countries. The ranges were set to sum up to the total recommended sample sizes for each country, after adjustments between target groups in countries where more than one group was interviewed. The targeted sample sizes represent the net interviews. To estimate the size of the gross sample needed to achieve the net sample size, each country started with an assumption on the achievable response rate. Over the course of the fieldwork, in some countries addresses and/or PSUs (Primary Sampling Units) were issued in (random) stages to be able to reduce or

increase the number of issued addresses depending on the success rate in the field. Once an address was issued or a PSU was started it had to be finished by completing all required visits to the address or the PSU.

Russian minority

Table 4.4 shows the sample allocation for Russian minority populations in EU-MIDIS II. The sample size for the Russian minority target group in Latvia was increased compared with the sample size suggested by the optimal allocation method to reflect the larger population in Latvia as opposed to the size of the Russian minority population in Estonia and Lithuania (see Table 4.4).

Roma target group

In the majority of the countries where Roma were surveyed in EU-MIDIS II, the final sample size was within the range of the optimal allocation calculations (see Table 4.5). Following the optimisation procedures, the final overall target sample size for the Roma target group was increased (from 6,400 interviews at the start of the contract, to 7,750 interviews). This adjustment was offset against reductions in sample sizes in some of the other countries, which provided additional resources in these countries, which were used to make improvements to sample quality. In countries with less reliable sampling frames (EL, ES, HR and PT) and for reasons of cost and available interviewing capacity, the planned sample size was not increased up to the suggested optimal allocation. This mainly affected the sample in Spain. The overall weighting efficiency of the cross-country Roma sample was 77 %.

Immigrants and descendants of immigrants from Turkey

The overall planned sample size for immigrants and descendants of immigrants from Turkey was 3,500 (Table 4.6). Between the six countries where this group was interviewed, the sample sizes were adjusted to reflect the relative sizes of the target populations in a country, and in most cases the target sample size

Table 4.4: Allocation of sample sizes: Russian minority

Country	Russian population (all ages)*	Optimal allocation range – lower bound (N)	Optimal allocation range – upper bound (N)	Target sample size (N)	Achieved sample size (N)
EE	321,024	410	449	400	401
LT	176,913	400	436	400	404
LV	557,119	465	540	550	614
Total	1,055,056			1,350	1,419

Note: * Figures derived from Census 2011.

Source: FRA, EU-MIDIS II 2016

Table 4.5: Allocation of sample sizes: Roma

Country	Roma population (all ages)*	Optimal allocation range – lower bound (N)	Optimal allocation range – upper bound (N)	Target sample size (N)	Achieved sample size (N)
BG	325,343	942	982	1,050	1,078
CZ	237,865	840	864	850	817
EL	62,920	432	639	500	508
ES	550,000	1,105	1,277	700	776
HR	16,975	400	524	500	538
HU	315,583	934	968	1,050	1,171
PT	39,233	400	588	500	553
RO	621,573	1,150	1,358	1,450	1,408
SK	402,590	1,003	1,093	1,150	1,098
Total	2,572,082			7,750	7,947

Note: * The estimate for Spain is based on information from the Fundación Secretariado Gitano; for the sources for the other countries, see Table 4.11.

Source: FRA, EU-MIDIS II 2016

is within the range suggested by optimal allocation. Population estimates were only available for the first generation of immigrants. For the calculation of optimal allocation, population sizes were increased by 50 % to account for the second generation.

To reflect the large Turkish population in Germany appropriately, it would have been desirable to increase the size of this sample even further. However, due to a lack of better sample frames, the sample in Germany has lower precision and coverage compared with samples of other countries where immigrants and descendants of immigrants from Turkey were interviewed.

Taking also into account the fieldwork costs, a further increase of the sample size in Germany would not have improved the quality of the results to the extent as to justify the necessary additional investment. The overall weighting efficiency of the Turkish sample across the six EU Member States is 41 %, and it would have been necessary to increase the German sample size towards the upper limit of the optimal allocation range to make a notable improvement to this.

After the start of fieldwork, the planned sample size in Denmark was reduced to from 500 to 450 interviews due to difficulties reaching the original target.

Table 4.6: Allocation of sample sizes: immigrants and descendants of immigrants from Turkey

Country	Estimated size of target population (all ages) *	Optimal allocation range – lower bound (N)	Optimal allocation range – upper bound (N)	Target sample size (N)	Achieved sample size (N)
AT	239,820	400	521	550	578
BE	204,857	400	537	570	628
DE	2,877,000	912	1,386	880	919
DK	61,634	400	475	450	400
NL	396,414	514	590	600	617
SE	69,219	400	465	400	402
Total	3,848,944			3,500	3,544

Notes: In some countries, population estimates were available for first-generation immigrants only, so the available estimates have been increased by 50 % to account for the impact of including second-generation respondents in the target group of the survey. In Belgium, Denmark, Germany and the Netherlands, estimates of the total target group (first- and second-generation respondents) were available and no further adjustments were necessary.

* For the sources of the specified target populations, see Table 4.11.

Source: FRA, EU-MIDIS II 2016

Immigrants and descendants of immigrants from North Africa

The overall planned sample size for the target group 'immigrants and descendants of immigrants from North Africa' was 3,900 (see Table 4.7). All countries fit or are very near to the optimal allocation ranges proposed to distribute the available sample. The target sample size was not reached in France, as the combined sample for the two target groups in France yielded higher concentrations for immigrants and descendants of immigrants from Sub-Saharan Africa than expected and lower concentrations than estimated for immigrants and descendants of immigrants from North Africa in the selected PSUs. Consequently, the actual sample size for the group of immigrants and descendants of immigrants from North Africa was lower than planned and

the actual sample size for the second group in France (SSAFR) was higher than planned.²⁹

Immigrants and descendants of immigrants from South Asia

The target sample size for immigrants and descendants of immigrants from South Asia was reached in all three countries where this group was interviewed (see Table 4.8). In the United Kingdom the target sample size was originally set for 700 interviews, but this was later reduced to 600 interviews due to lower eligibility rates encountered during the fieldwork.

Table 4.7: Allocation of sample sizes: immigrants and descendants of immigrants from North Africa

Country	Estimated size of target population (all ages)*	Optimal allocation range – lower bound (N)	Optimal allocation range – upper bound (N)	Target sample size (N)	Achieved sample size (N)
BE	486,645	556	671	700	711
ES	1,149,398	698	740	750	787
FR	5,313,000	1,131	1,501	1,100	846
IT	925,242	626	705	700	836
NL	421,803	518	652	650	653
Total	8,296,088			3,900	3,833

Notes: Population figures were available for only first-generation immigrants in France, Italy and Spain. These estimates have been increased by 50 % to account for the impact of including second-generation respondents in the target group of the survey.

* For the sources for the specified target population estimates, see Table 4.11 (sample frames).

Source: FRA, EU-MIDIS II 2016

Table 4.8: Allocation of sample sizes: immigrants and descendants of immigrants from South Asia or Asia

Country	Estimated size of the population (all ages)*	Optimal allocation range – lower bound (N)	Optimal allocation range – upper bound (N)	Target sample size(N)	Achieved sample size(N)
CY**	22,124	N/A	N/A	400	436
EL	84,755	400	470	500	515
IT	574,151	549	582	500	517
UK	1,075,331	649	751	600 (700)	668
Total	1,734,236			2,000	2,136

Notes: * For the sources for the population estimates, see Table 4.11. All population estimates for this group were available for first-generation immigrants only, so the estimates have been increased by 50 % to account for the impact of including second-generation respondents in the target group of the survey.

**Cyprus is the only country with the Asian target group so optimal allocation is not applicable (N/A).

Source: FRA, EU-MIDIS II 2016

²⁹ This was also related to difficulties in estimating the concentrations in advance, because the detailed data on the target group were not available at the PSU level and had to be estimated.

Immigrants and descendants of immigrants from Sub-Saharan Africa

The sample sizes for the target group immigrants and descendants of immigrants from Sub-Saharan Africa was adjusted as far as possible to reflect the relative sizes of the target populations in the country (see Table 4.9). In particular, the UK sample size was increased to 700 interviews to reflect the larger population in this country, and the samples were reduced to the minimum size of 400 in countries with relatively small populations (Ireland, Malta and Sweden). In France, the sample

would have benefited from a further increase, but this would have led to a loss of sample efficiency within the French sample overall, given that the other target group in France – immigrants and descendants of immigrants from North Africa – has a population twice the size of the Sub-Saharan population in France. After the start of fieldwork, the sample sizes in Austria and Denmark were also reduced, from 500 to 400 interviews, due to difficulties in achieving the original target sample sizes. Finally, the target was also reduced in the UK in the course of the fieldwork from 700 to 600 due to lower than expected eligibility rates.

Table 4.9: Allocation of sample sizes: immigrants and descendants of immigrants from Sub-Saharan Africa

Country	Sub-Saharan population (all ages)*	Optimal allocation range - lower bound (N)	Optimal allocation range - upper bound (N)	Target sample size(N)	Achieved sample size(N)
AT	30,831	400	428	400 (500)	476
DE	251,000	400	499	500	500
DK	39,085	400	439	400 (500)	451
FI	31,059	400	435	500	502
FR	1,858,500	620	851	500	794
IE	59,712	400	439	400	425
IT	452,129	420	508	500	369**
LU***	21,607	N/A	N/A	400	402
MT	5,700	400	415	400	411
PT	532,979	456	518	500	525
SE	201,048	400	472	400	400
UK	1,961,738	626	874	600 (700)	548
Total	5,445,388			5,500	5,803

Notes: * For the sources of the specified population estimates, see Table 4.11 (sample frames). In some countries, population estimates were available for first-generation immigrants only, so these estimates were increased by 50 % to account for the impact of including second-generation respondents in the target group of the survey. In Denmark, Finland, Germany and Malta, estimates of the total target group (first- and second-generation respondents) were available.

** In Italy, the three target groups were sampled simultaneously and the fieldwork resulted in fewer interviews of immigrants and descendants of immigrants from Sub-Saharan Africa than planned (below the minimum of 400 interviews per group), while more interviews with immigrants and descendants of immigrants from North Africa were achieved.

*** The target group originally planned for Luxembourg was recent immigrants, so Luxembourg was not considered in the optimal allocation of the sample concerning immigrants and descendants of immigrants from Sub-Saharan Africa. During the implementation of the survey, however, the target group in Luxembourg had to be changed, because it was not possible to access the required sample frame to draw a sample of recent immigrants; the decision was made to change the target group in Luxembourg to immigrants and descendants of immigrants from Sub-Saharan Africa.
N/A = not applicable.

Source: FRA, EU-MIDIS II 2016

Recent immigrants

The sample allocations were not revised from the initial levels for the remaining target groups. All three target groups were set at the minimum country/target group

level of 400 interviews. This meant that there was no room to further optimise the sample allocations for these target groups.

Table 4.10: Allocation of sample sizes: immigrants and descendants of immigrants from Asia and recent immigrants

Country	Target group population (all ages)*	Target sample size (N)	Achieved sample size (N)
PL	15,612	400	429
SI	36,523	400	404
Total	52,135	800	833

Note: *For the sources for the specified population estimates, see Table 4.11 (sample frames).

Source: FRA, EU-MIDIS II 2016

4.3. Sample frames and mapping of available information for sampling

One of the main objectives for the sampling strategy of EU-MIDIS II was to achieve representativeness through random probability sampling for all target groups in each of the 28 EU Member States. Therefore the following aspects were considered when mapping information in order to decide upon the specific sampling strategy for each target group in each country:

- a) the size of the population (for each target group);
- b) the geographical concentration of the target group (based on addresses);
- c) if no address frame is available in the country for sampling purposes, in which locations or 'centres' the target group congregates; this includes any locations of meeting and work, not to be defined too narrowly and listed in the order of magnitude, with size estimates if necessary;
- d) assessment of difficulty of surveying the group and any social network aspect of that particular group;
- e) qualitative assessment: how reclusive is that population?;
- f) identification of further lists and assessment of possible use, e.g. if telephone screening lists are available;
- g) identification of characteristics of the target population, including country of birth, years of residence, regional information, etc.

In order to carry out this assessment, information from a number of available sources were used, including available statistics as well as expert assessments. The target population size was examined primarily based on registers data, results of the 2011 census 2011, Labour Force Survey (LFS) and other available survey data.

The Central Coordination Team used the information to develop a sampling strategy for each target group and country. National Survey Experts were asked to provide comments on the sampling strategy as well as to assess the information on the basis of which the sampling strategy had been developed. The information concerning the distribution of the target population within the country was used to decide on the survey's regional coverage and how to define a cut off point for areas with low density. Screening of addresses becomes feasible only at around a 5-10 % concentration of the target population. A 5 % concentration means that, on average, it is necessary to screen 20 households successfully to find one eligible household. This is a very costly approach that makes it necessary to choose a cut-off point for areas with low density in countries without an individual sample frame.

Given that most of the target groups in EU-MIDIS II can be considered hard to reach for survey research – in terms of being relatively small in size and/or dispersed finding a suitable sample frame in each country was a critical part of the preparatory work for the survey. For most countries, physical access to the sampling frame was needed for optimising the sample design. In several cases, FRA had to provide support to the national survey companies to obtain access to the full frame, such as the full list on census district level with number of persons of the target group of country of birth. The statistical offices had to comply with data protection rules and could grant access only when FRA directly requested the access and ensured the purpose of the survey and confidential treatment of the data.

Table 4.11 lists the sample frames used for each country and target group. Sample frames that allowed direct identification of eligible individuals – based on up-to-date population registers – were preferred over other frame types because they could offer a high level of quality and efficiency. Full access to register-based individuals from this type of frame was possible in Denmark, Finland and Poland.

If a population register was not available or not accessible to the survey research agencies working on EU-MIDIS II for FRA, the next option was to find a sample frame that would allow indirect sampling of the target groups. This type of sample frame would allow – in the first stage – selecting a sample of small areas of the country where the survey’s target group is living, followed by screening the areas in a second stage to find people who are eligible to take part in the survey (see Section 4.4 for details concerning the methods in this second-stage sampling). This type of primary sampling unit frame was available in a majority of the countries (21 EU Member States) where suitable individual-level frames do not exist or could not be accessed in EU-MIDIS II. Due to the need for a second sampling stage when using these frames, sources that would allow selection of household/dwelling addresses from a register was preferred over random route sources. These address lists were available in four out of the 21 countries where two-stage selection was necessary (see Table 4.11).

Obtaining adequate sample frames that could be used in the EU-MIDIS II survey was both time consuming and labour-intensive. The official requests for access to sample frames were made to the national statistical institutes in February 2015. At the start of the pilot data collection in July 2015 sample frames access to sampling frames had been obtained in most countries. However, it was not possible to obtain sample frames from official sources in Germany, Malta or Sweden, or instead of the preferred sample frames, another frame had to be accepted. Organisations responsible for official records in these three countries referred to data protection laws as grounds for not granting access to their information. In other countries, different problems were encountered in various stages of the sampling procedure:

- In Finland, the main African languages spoken by Sub-Saharanans were initially used as a selection criteria when drawing a sample of individuals from the population register, instead of basing the selection on the country of birth which also would have been available in the register. This meant that Sub-Saharanans who listed their main language as English, French, Portuguese or Finnish were initially excluded. Since this corresponds to some 34 % of the target population, and as it turned out the initial sample was not large enough, a second sample

was drawn from the population register during the fieldwork. This new sample was selected to over-represent the group that had been excluded from the first sample, so that the final achieved sample was well-balanced as to the main language spoken by the respondents.

- In Italy, the data initially available for sampling purposes referred to geographic units – communes, which cover whole settlements including cities – that were too large to be used as primary sampling units. Further, the request made to the Italian National Institute of Statistics (ISTAT) for data at a smaller geographic level could not be processed in time for the pilot data collection. By the main stage fieldwork suitable sample frame data for Italy were received from ISTAT.
- In Luxembourg, FRA made a request to the national registry holder for access to their register for the purposes of EU-MIDIS II. However, despite significant efforts over the course of the year, it was not possible to obtain addresses for contacting respondents face-to-face. As a result, two changes were made to the sample design in Luxembourg. First, the target group was changed from ‘recent immigrants’ to ‘immigrants and descendants of immigrants from Sub-Saharan Africa’, as the latter are a relatively more homogenous group and geographically less dispersed in Luxembourg. Second, in the absence of access to register data the sampling methodology was changed to quota sampling.
- In Slovenia, the original sample design assumed the direct sampling of the target population using data from the national register, but direct access to the register was denied with reference to existing data protection regulations. The sample design was therefore changed and an indirect sampling approach, which required screening for the target group, was adopted for the main stage fieldwork. The statistical office offered to deliver instead a list of addresses of the general population but with an oversample of the target group.
- In Germany the telephone directory was used – as a form of individual-level sample frame – to apply an onomastic sampling approach, which involved pre-screening entries from the telephone directory to identify people who are likely to belong to the survey’s target groups based on their names. This approach was taken due to a change in law, which at the time of the survey meant that municipal authorities in Germany were not able to provide sampling data for surveys. Such sampling frame may introduce a bias to the sample, excluding those who cannot be identified via name and persons not registered in the telephone directory. Additional

sampling by referrals (see [Section 4.6](#)) was applied to address the possible bias in this regard.³⁰

- In Malta, the population statistics that would have been necessary to inform the sample design are not collected by the authorities.
- In Sweden, legislation forbids the use of register data for selecting persons on the basis of their race,

ethnicity, political views or religious beliefs. However, data at the regional level were obtained and proved helpful for planning the location sampling in Sweden.

Table 4.11 gives an overview of sampling frames used for each target group in each country. Most samples were stratified to control for region and urban density.

Table 4.11: EU-MIDIS II sample frames by country and target group

Country	Target group*	Sample frame/source of data used for sampling	Sample frame and selection stages	Stratification variables
AT	SSAFR	Population register 2014 and Austrian Post	Enumeration districts or <i>Zählsprenkel</i> (PSUs) and addresses (selection)	NUTS2, DEGURBA
	TUR	Population register 2014 and Austrian Post	Enumeration districts or <i>Zählsprenkel</i> (PSUs) and addresses (selection)	NUTS2, DEGURBA
BE	NOAFR	Census 2011 and Orgassim	Census areas or <i>statistische Sector</i> (PSUs) & addresses (selection)	NUTS2, DEGURBA
	TUR	Census 2011 and Orgassim	Census areas or <i>statistische Sector</i> (PSUs) and addresses (selection)	NUTS2, DEGURBA
BG	ROMA	Census 2011	Census areas (PSUs)	NUTS3, rural/urban
CY	ASIA	Census 2011	City district level 'ΕΝΟΠΙΑΣ' (larger cities) or municipality/community 'ΔΗΜΟΥ/ΚΟΙΝΟΤΗΤΑΣ' (PSUs, larger settlements divided)	LAU1, DEGURBA
CZ	ROMA	Census 2011 and total number of Roma estimates	Municipality (PSUs, larger settlements divided)	NUTS3, urban/rural
DE	SSAFR	H&S onomastic (survey) and Microcensus 2013 (population adjustments)	Settlements (PSUs) and individual (selection)	BIK and Nielsen territory**
	TUR	H&S onomastic (survey) and Microcensus 2013 (population adjustments)	Settlements (PSUs) and individual (selection)	BIK and Nielsen territory
DK	SSAFR	Population register 2015	Municipality (for mapping and coverage)	N/A
	TUR	Population register 2015	Municipality level (for mapping and coverage) and individual level (selection)	Sample not stratified

³⁰ Research on the application of onomastic sampling among immigrants in Germany has shown that there is indeed a bias for some outcomes resulting from this method. However, the overall bias is not necessarily considerably large. See Schnell *et al.* (2014). The bias for EU-MIDIS II is assumed to be mitigated by adding the referral sample.

Country	Target group*	Sample frame/source of data used for sampling	Sample frame and selection stages	Stratification variables
EE	RUSMIN	Census 2011	Municipality or <i>omavalitsus (linn, vald)/linnaosa</i> (PSUs, larger settlements divided)	LAU1, DEGURBA
EL	ROMA	Roma Pilot Survey 2011	Municipality (PSUs, larger settlements divided)	NUTS2, rural/urban
	SASIA	Census 2011	Census areas (PSUs)	NUTS3, DEGURBA
ES	ROMA	Gitanos.org 2007 data	Municipality or <i>municipio</i> (PSUs, larger settlements divided)	NUTS2, settlement size
	NOAFR	Census 2011	Census sectors (PSUs)	NUTS2, DEGURBA
FI	SSAFR	Population register 2015	City (for mapping and coverage) and individual (selection)	Sample not stratified
FR	SSAFR	Census 2011 and foreign-born estimates	Commune for target group and IRIS ('Aggregated units for statistical information' – translated from French) for foreign-born (PSUs)	NUTS2, DEGURBA
	NOAFR	Census 2011 and foreign-born estimates	Commune for target group and IRIS for foreign-born (PSUs)	NUTS2, DEGURBA
HR	ROMA	Census 2011	Settlements or <i>naselje</i> (PSUs, larger settlements divided)	NUTS3, urban/rural
HU	ROMA	Census 2011	Enumeration district (PSUs)	NUTS2, rural/urban
IE	SSAFR	Census 2011 and An Post (Irish postal system)	Census small areas (PSUs) and addresses (selection)	NUTS3, DEGURBA
IT	SSAFR	Census 2011	Census areas or <i>sezioni di censimento</i> (PSUs)	NUTS2, DEGURBA
	NOAFR	Census 2011	Census areas or <i>sezioni di censimento</i> (PSUs)	NUTS2, DEGURBA
	SASIA	Census 2011	Census areas or <i>sezioni di censimento</i> (PSUs)	NUTS2, DEGURBA
LT	RUSMIN	Census 2011	<i>Seniunija</i> (only available for Vilnius) and municipality (all others) used for target group populations, general population data on electoral districts to divide into PSUs	LAU1
LU	SSAFR	General Social Security Inspectorate (IGSS) statistics 2015	National level only	Sample not stratified
LV	RUSMIN	OMCA registry statistics and election results estimates	Municipality and enumeration district 'RĪGAS APKAIMĒM' (PSUs)	Municipality
MT	SSAFR	No official statistics, population size estimated from desk research	N/A	Sample not stratified

Country	Target group*	Sample frame/source of data used for sampling	Sample frame and selection stages	Stratification variables
NL	NOAFR	Population register 2014 and Cendris (Dutch register of postcodes)	5-digit postcodes (PSUs) and address (selection)	Region, DEGURBA
	TUR	Population register 2014 and Cendris (Dutch register of postcodes)	5-digit postcodes (PSUs) and address (selection)	Region, DEGURBA
PL	RIMGR	Census 2011 and PESEL (Universal Electronic System of Population Register) registry data and Centre for Migration Research (CMR) estimates	Addresses after aggregation of individual register (from PESEL)	City area
PT	ROMA	Roma Pilot Survey 2011	Municipality 'MUNICÍPIO' (PSUs, larger settlements divided)	NUTS2, settlement size
	SSAFR	Census 2011 and naturalised immigrant estimates	Statistical sectors or <i>secção</i> (PSUs)	NUTS3
RO	ROMA	Census 2011	Census districts (PSUs)	NUTS3, urban/rural
SE	SSAFR	Population register 2014	Municipality (for mapping and coverage)	N/A
	TUR	Population register 2014	Municipality (for mapping and coverage)	N/A
SI	RIMGR	Population register	Individuals (selection)	LAU2, urban/rural
SK	ROMA	Atlas 2013	Municipality (PSUs, larger settlements divided)	NUTS3, urban/rural
UK	SSAFR	Census 2011 and Post Office Address File	Census output areas (PSUs) and addresses (selection)	NUTS2, DEGURBA
	SASIA	Census 2011 and Post Office Address File	Census output areas (PSUs) and addresses (selection)	NUTS2, DEGURBA

Notes: * NOAFR, immigrants and descendants of immigrants from North Africa; SASIA, immigrants and descendants of immigrants from South Asia; SSAFR, immigrants and descendants of immigrants from Sub-Saharan Africa; TUR, immigrants and descendants of immigrants from Turkey.

** Measure of population size of a location provided by the BIK Institute (BIK Aschpurwis + Behrens), and regional divisions provided by the Nielsen Company.

N.A. = not applicable.

Source: FRA, EU-MIDIS II 2016



4.4. Overview of sampling methodologies used

This section describes the sampling methodologies used for the EU MIDIS II survey. A number of different sample designs were used. Proposals on sampling and selection strategies were based on statistical grounds considering a balance between precision, feasibility and costs. The main reference design in EU-MIDIS II was a household-based survey of individual persons. For most target groups and in most countries, in the absence of individual registers with country of birth and parents' country of birth information, an area-based sample design was used.

In most cases areas were selected in a single sampling stage with probability proportional to target population size (stage 1), followed by the selection of households and respondents within households (stage 2). First contact was made face-to-face in all countries except in Denmark and Finland, where the sampled persons were first screened for eligibility via telephone, and an appointment for face-to-face interview was made with respondents who were confirmed on the phone as being eligible to take part in the survey.

The following sample design approaches were used in EU-MIDIS II. In some countries, a combination of sampling designs was used:

1. Direct unclustered single-stage sampling selecting from individual person-level registers (three countries).
2. Multi-stage area sampling, with primary sampling units (PSUs) selected at the first stage. For the second stage sampling within sample areas the choice is generally between: (i) systematic sampling from existing population lists, where such lists are available, and (ii) random route sampling. EU-MIDIS II used these approaches as follows:
 - a. systematic sampling from address registers (in four EU Member States);
 - b. addresses identified via random route (in 15 EU Member States);
 - c. in Germany random walk route was assessed as not to be feasible and therefore addresses were identified through an onomastic (name matching) process and via referrals.
3. Location sampling or centre-based sampling (in seven EU Member States).
4. A non-probability sampling in Luxembourg (quota sampling) after requests for register

data were rejected and other forms of sampling were not feasible.

In the case of the most prevalent sampling design approach No. 2 (multi-stage area sampling), screening is required in the second stage of the sampling to identify eligible individuals within the areas selected in the first sampling stage. Screening is a major component of survey fieldwork costs, and can be a particular burden to interviewers in low concentration areas where eligible individuals are rare. The efficiency of the sample depends greatly on how the area units are selected. Therefore various measures were taken in EU-MIDIS II to increase feasibility and efficiency of screening:

- (1) Identification and exclusion of practically 'empty' primary sampling units – that is, PSUs where eligible individuals would be extremely rare;
- (2) Classification of the remaining areas according to the degree of concentration of the target population. After classifying the areas, it is possible to determine an appropriate cut-off point for excluding low concentration areas, along with an estimate of the proportion of the target population (see section 4.5 on coverage). Strata with higher concentrations can be over-sampled.
- (3) Supplementary procedures when the main area-based design is not able to provide an adequate or efficient design are adaptive cluster sampling (ACS) or focused enumeration (FE),³¹ which were both used in EU-MIDIS II. Where neither ACS nor FE were feasible – or to complement other methods – location sampling was used.

Coverage and efficiency of design

To improve the efficiency of the screening and fieldwork related efforts and costs, country sampling plans were optimised through stratification of the frame according to degree of concentration of the target population (i.e. percentage of target population in the total population of the PSU), and by

- excluding empty or low concentration strata from the sample by setting a minimum level of concentration 'cut-off' (see Table 4.12 for details of the countries where a concentration cut-off was set) and/or
- oversampling more concentrated strata; this resulted in lower sample efficiencies (see Table 4.13 for details of the countries where over-sampling was undertaken, and efficiency of the design).

³¹ These two methods are described under the respective sample designs.

In the majority of the EU Member States, the sampling design targeted national coverage of the target population. In the absence of sampling frames that allow for identifying the target group it was decided to exclude areas with low concentration of the target populations, as screening would become unfeasible or too expensive. Screening for a population with less than 5 % concentration was considered to be inefficient in terms of costs and interviewer motivation.³²

Previous analysis shows, for instance, that Roma who live in more segregated areas are more vulnerable to poverty and social exclusion.³³ ‘Segregation’ was defined by a three-category scale of interviewer’s perception. However, it is very difficult to define segregation in terms of concentration of the target population. Concentrations of 5–10 % can reflect a rather dispersed population in an urban area, or a highly segregated settlement within a rural area. Research in this area remains qualitative or based on non-probability sampling. Based on the assumption that target populations below 5–10 % do not differ significantly from those just above this threshold, the survey aimed rather for national coverage, to represent the diversity of populations in a country, and aimed in particular to include rural areas.³⁴ Given the mostly high coverage of Roma respondents, the assumption holds that the majority of Roma live in areas of higher concentration, and the inclusion of very low concentrated areas may not affect the results significantly. Further research is necessary on a possible bias resulting from non-coverage, and on possible changes in processes of self-identification based on ethnicity.

To achieve national coverage, the sample frames for each country were sorted by concentration and the lowest concentration strata excluded irrespective of region/city. However, national coverage was not possible in all countries because of restrictions on the availability of specially trained interviewers, and costs. In Austria, Denmark, Finland, Greece, Luxembourg, Poland, Portugal (immigrants and descendants of immigrants from Sub-Saharan Africa only), the Netherlands, Slovenia and Sweden, the fieldwork was restricted to specified cities/regions. The included regions/cities were in all instances chosen on the basis of having the largest numbers of the target group populations in the country. In most of these countries, the coverage loss from this restriction was fairly small, no more than 20 % of the target population. The exceptions were Greece and the Netherlands, where regional restrictions resulted in initial coverage losses of 33 % and 39 % respectively. Thereafter, the sample frames in these countries were also partitioned and low concentrated PSUs within the covered cities/regions were dropped from the sample, following in the same approach as in other survey countries, which results in a further reduction of coverage (see Table 4.12 for details).

Table 4.12 presents the sampling methods used in each country, the number of interviews permitted per household, the concentration cut-offs set when selecting areas (where applicable) and the population coverage that was achieved after exclusion of low-concentration strata as well as regions/cities where the population size of the target groups was small. Details of any over-sampling undertaken are provided later in this section.

³² In the case of 5 % concentration of the target population, 20 addresses must be successfully screened before 1 eligible respondent can be reached. Given a successful screening rate of 80 % with at least three contact attempts and a 50 % response rate, it means that 50 households/addresses need to be contacted for a single interview. In practice, cut-offs were set at between 2 % and 20 % concentration of the target population (see Table 4.12).

³³ See FRA (2014).

³⁴ Further research is needed to define and identify segregated areas and to confirm this assumption. Furthermore, non-coverage weights were discussed and a decision was taken not to apply such weights due to unavailability of relevant data.



Table 4.12: Overview of EU-MIDIS II sampling methods, by country and target group

Country	Target group*	Sampling method	Maximum number of interviews per household	Target sample size (N)	Cut-off level and selection criteria	Population coverage after cut off and exclusion rules
AT	SSAFR	Address register with FE ^a (2a: indirect, ^b multi-stage stratified) and location sampling (3)	1	400	Areas with > 7.5 % concentration	35 % of the Address register; with location sampling up to 69 % ^c
	TUR	Address register with FE (2a: indirect, multi-stage stratified)	2	550	Areas with > 5 % concentration	49 %
BE	NOAFR	Address register with FE (2a: indirect, multi-stage stratified)	2	700	Areas with > 9.5 % concentration	55 %
	TUR	Address register with FE (2a: indirect, multi-stage stratified)	2	700	Areas with > 8.5 % concentration	51 %
BG	ROMA	Random route with ACS ^d (2b: indirect, multi-stage stratified)	1	1,050	Areas with > 10 % concentration and areas with > 20 Roma households	At least 70 %
CY	ASIA	Location sampling (4) + Random route with FE (2b: indirect, multi-stage stratified)	1 (location sampling), 2 (random walk)	400	Areas with > 2.7 % to > 7.4 % concentration ^e	43 % for Random route; with location sampling up to 89%
CZ	ROMA	Random route (2b: indirect, multi-stage stratified)	1	850	Areas with > 139 Roma persons (~ 30 Roma households) and, among areas with 139–500 Roma persons, areas with > 10 % concentration	79 %
DE	SSAFR	Onomastic, multi-stage stratified + referrals (2c)	2	500	Municipalities with > 5 onomastic addresses or > 40 when no statistical twin in the same stratum (BIK/Nielsen)	75% ⁱ with referrals
	TUR	Onomastic, multi-stage stratified + referrals (2c)	2	880	Municipalities with > 5 onomastic addresses or > 40 when no statistical twin in the same stratum (BIK/Nielsen)	97 % with referrals
DK	SSAFR	Location sampling (3)	1	400	Most populous areas selected: Aalborg, Århus, Esbjerg, Frederiksberg, Holbæk, Copenhagen, Odense, Rødovre, Roskilde, Slagelse, Viborg	Up to 63 %
	TUR	Register (2: direct, simple random sample)	2	450		60 %
EE	RUSMIN	Random route (2b: indirect, multi-stage stratified)	1	400	Areas with > 30 % concentration	73 %

Country	Target group*	Sampling method	Maximum number of interviews per household	Target sample size (N)	Cut-off level and selection criteria	Population coverage after cut off and exclusion rules
EL	ROMA	Random route (2b: indirect, multi-stage stratified)	1	500	Selection of regions of Attica, Western Greece, Central Macedonia, Thessaly	64 %
	SASIA	Random route with FE (2b: indirect, multi-stage stratified)	2	500	Largest region selected, Attica (covered 67 %) and areas > 5 % concentrations	21 %
ES	ROMA	Random route (2b: indirect, multi-stage stratified)	1	700	Areas with > 200 Roma households and < 10 % concentration	65 %
	NOAFR	Random route with FE (2b: indirect, multi-stage stratified)	2	750	Areas > 3.5 % concentration	55 %
FI	SSAFR	Register (2: direct, simple random sample)	1	500	Selected largest cities of the Helsinki metropolitan area, as well as Oulu, Tampere, Turku and Vaasa (total coverage of 86 %)	17 % ⁹
FR	SSAFR	Random route with ACS (2b: indirect, multi-stage stratified)	2	500	Areas with > 5 % concentration	63 %
	NOAFR	Random route with ACS (2b: indirect, multi-stage stratified)	2	1,100	Areas with > 10 % concentration	57 %
HR	ROMA	Random route with ACS (2b: indirect, multi-stage stratified)	1	500	Areas with > 200 Roma persons (~ 40 Roma households)	68 %
HU	ROMA	Random route with ACS (2b: indirect, multi-stage stratified)	1	1,050	Areas with > 10 % concentration	61 %
IE	SSAFR	Address register with FE (2a: indirect, multi-stage stratified)	2	400	Areas with > 7.5 % concentration	32 %
IT	SSAFR	Random route with FE (2b: indirect, multi-stage stratified)	2	500	Largest regions selected (covered 98 %) and > 2.75 % concentration	38 %
	NOAFR	Random route with FE (2b: indirect, multi-stage stratified)	2	700	Largest regions selected (covered 98 %) and > 3.1 % concentration	41 %
	SASIA	Random route with FE (2b: indirect, multi-stage stratified)	2	500	Largest regions selected (covered 98 %) and > 5.75 % concentration	38 %



Country	Target group*	Sampling method	Maximum number of interviews per household	Target sample size (N)	Cut-off level and selection criteria	Population coverage after cut off and exclusion rules
LT	RUSMIN	Random route with FE (2b: indirect, multi-stage stratified)	1	400	Most concentrated areas (Visagino sav., Klaipėdos m. sav., Zarasų r. sav., Švenčionių r. sav., Vilniaus m. sav.) (covered 63%) & >10 % concentration	53 %
LU	SSAFR	Quota sampling (4)	1	400	Largest areas selected (centre including Luxembourg City, North and South)	Up to 95 % ^h
LV	RUSMIN	Random route (2b: indirect, multi-stage stratified)	1	550	Largest cities selected (Riga, Dugavpils, Jelgava, Liepaja and Rezekne) (covered 65 %) and > 30 % concentration	56 %
MT	SSAFR	Location sampling (4)	1	400	N/A	Up to 100 % ⁱ
NL	NOAFR	Location sampling (4) + Address register with FE (2a: indirect, multi-stage stratified)	1 (location sampling), 2 (address register)	600	Largest areas selected (Amsterdam, The Hague, Rotterdam, Utrecht) (covered 61 %) and > 7.5 %	43 % (address sample), up to 53 % (with location sampling)
	TUR	Location sampling (4) + Address register with FE (2a: indirect, multi-stage stratified)	1 (location sampling), 2 (address register)	650	Largest areas selected (Amsterdam, The Hague, Rotterdam, Utrecht) (covered 56 %) and > 5 %	43 % (address sample), up to 50 % (with location sampling)
PL	RIMGR	Location sampling (4) + Address register (2: direct, simple random sample)	1 (location sampling), 2 (address register)	400	Largest areas selected (Gdańsk, Leśnica, Lublin, Poznan, Warsaw, Wrocław)	Registry, 37 %; with location sampling, up to 45 (based on census)
PT	ROMA	Random route (2b: indirect, multi-stage stratified)	1	500	Areas with > 60 Roma households and > 5 % concentration	70 %
	SSAFR	Random route with FE (2b: indirect, multi-stage stratified)	2	500	Largest region selected (Lisboa) (covered 76 %) and > 10 % concentration	41 %
RO	ROMA	Random route with ACS (2b: indirect, multi-stage stratified)	1	1,450	Areas with > 30 Roma households or > 10 % concentration	64 %
SE	SSAFR	Location sampling (3)	1	400	Largest areas selected (Göteborg, Malmö, Örebro, Jönköping, Stockholm, Uppsala and Umeå)	Up to ca. 51 % (based on figures for all of Africa)
	TUR	Location sampling (3)	1	400		Up to 62 %

Country	Target group*	Sampling method	Maximum number of interviews per household	Target sample size (N)	Cut-off level and selection criteria	Population coverage after cut off and exclusion rules
SI	RIMGR	Population register (2: indirect, unclustered)	2	400	Largest cities (Celje, Koper/Capodistria, Kranj, Ljubljana, Maribor, Nova Gorica, Novo Mesto and Velenje) and rural areas (Celje, Koper/Capodistria and Velenje) (covered 55 %)	30 % ^j
SK	ROMA	Random route (2b: indirect, multi-stage stratified)	1	1,150	Areas with > 30 Roma households or > 10 % concentration	75 %
UK	SSAFR	Address register with FE (2a: indirect, multi-stage stratified)	2	700	Areas with > 5.75 % concentration	60 %
	SASIA	Address register with FE (2a: indirect, multi-stage stratified)	2	700	Areas with > 16 % concentration	60 %

Notes: N/A = not applicable; ACS=adaptive cluster sampling; FE=focused enumeration.

*ASIA, immigrants and descendants of immigrants from Asia; NOAFR, immigrants and descendants of immigrants from North Africa; RIMGR, recent immigrants; ROMA, Roma; RUSMIN, Russian minority; SASIA, immigrants and descendants of immigrants from South Asia; SSAFR, immigrants and descendants of immigrants from Sub-Saharan Africa; TUR, immigrants and descendants of immigrants from Turkey.

^a Focused enumeration, a method of initial screening of the eligibility of households via proxy.

^b 'Indirect' sampling refers to the process whereby a geographic area was first selected and addresses therein sampled and issued to interviewers to conduct screening for the target group. 'Direct' means that individuals believed to be eligible were sampled from a population register, which contained information on eligibility.

^c The coverage figures provided for location sampling assume that all target group members living in the covered areas/cities could have been selected at one of the locations included in the fieldwork. In practice, the coverage is likely to be lower, as not all target group members living in selected areas would visit any of the locations. However, we could also expect that people who live in other areas, not included in the coverage calculations, would visit the locations.

^d Adaptive clustering, a method of screening adjacent households if a household is eligible, assuming non-random clustering of target groups.

^e The sample was planned and selected based on data of South and South Eastern Asians, and a 5 % concentration cut-off level. However, in error, fieldwork was conducted with Asians as the target group. This meant that in reality the effective cut off was 7.4 %, as all areas with concentrations of Asians above this level were included in the sample frame prior to selection. In addition, 21 out of 60 PSUs with Asian concentrations between 2.7 % and 7.4 % were covered.

^f The coverage of the onomastic sample in Germany was particularly low as cases were sampled from the telephone directory following an onomastic process to identify addresses likely to contain members of the target group based on the name listed. Coverage losses were the result of (i) households that are mobile-only and so do not have a phone number listed in the telephone directory, (ii) households with landlines that choose not to list their phone numbers in the telephone directory and (iii) target group members not identified by the onomastic process because they do not have a common Sub-Saharan African/Turkish surname. This resulted in coverage of 9 % for immigrants and descendants of immigrants from Sub-Saharan Africa, and 16 % for immigrants and descendants of immigrants from Turkey. In addition, further coverage losses occurred when dropping settlements with small numbers of addresses (25 % for immigrants and descendants of immigrants from Sub-Saharan Africa, and 3 % for immigrants and descendants of immigrants from Turkey). It can be expected that final coverage was significantly higher than the numbers for onomastic process suggest as referrals were also conducted (which could include individuals not identified by the onomastic sample provider) with a wide radius of 30 km from each onomastic address. Furthermore, the addresses identified through the onomastic procedure covered all regions of Germany. The coverage in the table is a rough estimate of the survey company taking the referrals into account.

^g The coverage in Finland includes the loss of 80 % of the planned level of coverage due to losses after sample selection at the telephone matching stage, where it was not possible to find telephone numbers for all selected individuals. The areas of the country covered included 86 % of the target group.

^h For Luxembourg, where quota sampling was used, we make a similar assumption to that for location sampling groups: that all target group members living in the coverage areas could have been sampled. No data were available to estimate coverage at a more detailed geographical level.

ⁱ Full coverage was theoretically possible in Malta because the locations selected could be reached easily from any part of the island. In practice, not all members of the target group will have visited one of the locations during the fieldwork. This may have been a particular issue for female respondents, who appear to be under-represented in the sample.

^j In addition to the coverage losses originally estimated, further loss of coverage resulted from the population register being able to deliver details only for those individuals who had agreed to be contacted for research purposes (54 % of the target population).

Source: FRA, EU-MIDIS II 2016

4.5. Direct single-stage sampling (design 1)

Direct sampling was used in Denmark, Finland and Poland, where it was feasible given the regional clustering of the target group (in particular in Finland). The addresses selected from the register are all believed to contain eligible members of the target group. In Poland, the register used did not cover the entire target group, because persons without a residence permit and naturalised immigrants were excluded to some extent (however, the sample was supplemented with location sampling, see design 3).

Furthermore, in Denmark and Finland, telephone pre-recruitment was used, which meant that in most cases only one visit was required to each household after the appointment was made on the phone. This meant that the unclustered sample was still feasible, in terms of interviewer travel time and related costs, in comparison with the face-to-face recruitment survey, which required multiple contacts. Telephone recruitment is the preferred recruitment method in the majority of the Nordic countries. The majority of people in these countries live in apartment blocks with locked outer doors, which makes access difficult without prior appointments. The country reports provide further details concerning the sampling in the respective countries.

4.6. Multi-stage area sampling (designs 2a, 2b, 2c)

This sampling approach was used in the majority of countries (21 out of 28) and involved the following broad stages, with some adaptations by country:

1. The sample frame was acquired on the most detailed regional level available and if necessary aggregated to a suitable geographic level that could be used as PSUs.
2. For each country and target group the sample design parameters were agreed with the national survey companies. These included sample size, target cluster size (number of interviews per PSU, set at 10 in the majority of PSUs), target response rate, expected number of interviews to be achieved on average per interviewed household (for target groups where two interviews were permitted), and – if data on first-generation immigrants only were available – the estimated multiplication factor to apply to the population statistics of the first generation to estimate the size of the full target group (first- and second-generation respondents).
3. For each PSU, the group concentrations were estimated (ideally, at household/address level, but if this was not possible then at individual adult (16+) level, and if not possible finally at individual (all ages) level). If necessary, estimates were refined based on local/expert information – which was required particularly in the case of Roma target group countries, or by apportioning target group numbers from data which was available only for higher-level geographic units. Specifically:
 - In Croatia, the Czech Republic, Greece, Portugal, Romania, Slovakia and Spain (Roma target group), Estonia and Lithuania (Russian minority), and Cyprus (immigrants and descendants of immigrants from Asia), data were available at settlement or municipality level only. It was therefore necessary to demarcate smaller areas to be used as PSUs, usually using maps, and then to estimate the target group concentrations within the smaller areas. This meant apportioning the target group population to these areas evenly, or using local knowledge to identify areas where the target group lives; see country reports for further details.
 - In France, commune-level data were available for the survey's target groups, while data on the number of all foreign-born people (i.e. born in any country outside of France) were available at a more detailed geographical level suitable for PSUs. In this instance, it was possible to set the target group numbers in proportion to the foreign-born population to obtain a reasonable estimate of target group concentrations at PSU level.
 - In Latvia, a similar solution was used to that in France. Target group data were available at municipality level only. The numbers in each electoral district were therefore estimated by apportioning the target group based on election results for the proportion voting for the two main Russian minority parties.
 - In Slovenia, the statistical office provided a random sample with an oversample of 20 % of the addresses to be eligible.
4. If over-sampling was applied, the sample frame was divided into target group concentration strata. For each target group, the samples were divided into five strata, with the concentration levels that defined the stratum boundaries set at a level that divided the target population into groups of roughly equal size. The lowest concentration stratum (proportion of the target population ranging from zero to the concentration cut-off specified in Table 4.12) was excluded from the survey. If multiple target groups were to be selected in a country from the same

frame, strata were specified across all target groups (interlocking cells), thereby increasing the number of strata. The sample design was then optimised to deliver the required sample size with maximum sample efficiency (see next section on oversampling)

5. Selection of the number of PSUs specified by the sample design, with stratification by concentration strata (disproportionate, if used), region and urbanisation (proportionate), and the selection usually made with probability proportional to size (PPS) and sometimes with equal probability within each concentration stratum (if used). The size measure used in PPS was the total number of addresses in each PSU, or the number of persons if number of addresses was not available, i.e. including eligible and ineligible, to counter the probability of selection at the next stage. Twice the number of PSUs as the number required were selected to have a reserve sample of PSUs in case needed. Where possible, each main sample PSU had a 'matched' reserve PSU. Implementing this involved selecting reserve PSUs from the same stratum and of the nearest size to their paired main PSUs.
6. Systematic selection of the specified number of addresses in each PSU, from an address or individual register, random route, or onomastic identification.

Table 4.13 provides details on the sample designs by country and target group, based on a multi-stage clustered sampling methodology used in 21 of the 28 EU Member States included in EU-MIDIS II. This includes the method used to select the PSUs, the expected and actual average target group concentration across the PSUs selected, and the estimated sample efficiency³⁵ due to over-sampling higher concentration strata where applicable. In countries where oversampling was not used, the table indicates 'N/A', not applicable. The variation of efficiency between countries and target groups was highly dependent on the dispersion of a population, and on the screening and interviewing costs in the respective country. Efficiency was higher when target groups were large and had a higher proportion in more concentrated areas, and lower when target groups were small and living rather dispersed.

³⁵ The effective sample size is calculated as the (sum of weights squared / sum of squared weights)/N. The sample efficiency figures provided in Table 4.13 account for the corrective weights required to re-balance a sample that was disproportionately sampled by concentration with a maximum of 100 % efficiency in a self-weighting design. They do not account for further efficiency losses arising from other parts of the weighting (Chapter 7 provides details).

As Table 4.13 shows, the estimated and actual target group concentrations differ in many countries. For the majority of the Roma and Russian minority target groups, the fairly wide discrepancies between estimated and actual concentrations in some countries are not surprising because the expected concentrations were based on fairly rough estimates. Most of the actual field concentrations for Roma were better than those estimated, as identification of the selected sub-areas in the sample drew on local knowledge, whereas the concentration assumptions were based on data, which gave the average across a much larger area. These and other differences sometimes affected the number of interviews that were delivered, as discussed later in this section (see 'fieldwork outcome').

Oversampling concentration strata

In most countries, EU-MIDIS II sampled PSUs with larger numbers of members of the target group populations with higher probability, to increase cost efficiency and feasibility of the samples reaching elusive populations. This approach requires weighting, and decreases the sample efficiency. For a given resource outlay, measured as the number of addresses selected and issued to interviewers for screening, oversampling was optimised to maximise sampling efficiency and use of resources.

The sample frames were first partitioned into multiple target group concentration strata. A concentration cut-off was set for the target group(s); this was the threshold for exclusion from the sample. The coverage figures provided in Table 4.13 give the proportion of the target group living in areas above the threshold. For a country with a single target group, optimisation was then achieved by selecting the sample of addresses within each concentration stratum using a sampling fraction, calculated as a function of the square root of its target group concentration, given by the formula below:

$$r_h = r \times \frac{N_h \times D_h^a}{\sum_h N_h \times D_h^a}$$

$$\text{where: } r_1 = 0 \quad \sum_h r_h = r$$

and: r_h = addresses to sample per stratum h ;

r = target number of addresses to sample overall;

N_h = concentration percentage of the target group/combined target groups (if multiple) in stratum h ;

D_h = number of addresses/households overall in stratum h ;

a = power adjustment; for optimal allocation $a = 0.5$.



Table 4.13: Details of multi-stage clustered sample designs

Country	Target group*	PSU selection method	Expected (actual) concentration in the sampling frame/selected areas (%)	Sample efficiency (accounting for oversampling) (%)
AT	TUR	PPS	16 (14)	73
BE	NOAFR	PPS	30 (15)	81
	TUR	PPS	30 (15)	68
BG	ROMA	PPS	36 (53)	97
CY	ASIA	PPS	11 (10)	49
CZ	ROMA	PPS	24 (66)	N/A
DE	SSAFR	PPS	Close to 100 (93)	N/A
EE	RUSMIN	PPS	64 (84)	96
EL	ROMA	PPS	74 (67)	N/A
ES	ROMA	Equal probability	28 (21)	N/A
	NOAFR	PPS	16 (9)	62
FR	SSAFR	PPS	39 (32)	69
	NOAFR	PPS	39 (32)	69
	TUR	PPS	Close to 100 (93)	N/A
	SASIA	PPS	16 (14)	42
HR	ROMA	PPS	57 (56)	N/A
HU	ROMA	PPS	38 (69)	74
IE	SSAFR	PPS	19 (7)	50
IT	SSAFR	PPS	20 (16)	31
	NOAFR	PPS	20 (16)	34
	SASIA	PPS	20 (16)	33
LT	RUSMIN	PPS	18 (15)	N/A
LV	RUSMIN	PPS	53 (66)	88
NL	NOAFR	PPS	34 (17)	53
	TUR	PPS	34 (17)	49
PT	ROMA	PPS	90 (74)	N/A
	SSAFR	PPS	24 (31)	82
RO	ROMA	Equal probability	18 (29)	N/A
SK	ROMA	PPS	35 (58)	N/A
UK	SSAFR	PPS	35 (23)	54
	SASIA	PPS	35 (23)	49

Notes: N/A=not applicable.

*ASIA, immigrants and descendants of immigrants from Asia; NOAFR, immigrants and descendants of immigrants from North Africa; PPS, probability proportional to size; ROMA, Roma; RUSMIN, Russian minority; SASIA, immigrants and descendants of immigrants from South Asia; SSAFR, immigrants and descendants of immigrants from Sub-Saharan Africa; TUR, immigrants and descendants of immigrants from Turkey.

Source: FRA, EU-MIDIS II 2016

If required, the power adjustment was increased iteratively so that the sample design delivered the target number of interviews (given the fieldwork assumptions) from the target number of sampled addresses.

In countries with multiple target groups, where the selection of PSUs was made once and from a single

sample frame, the solution would deliver numbers of interviews with each group in proportion to their relative numbers on the sample frame. Usually, these numbers did not meet the target sample sizes for each group, necessitating a further adjustment to force the sample towards PSUs with relatively more of the under-represented target group. This was achieved by

assigning an adjustment weight to the concentration of each target group, for example for two target groups:

$$N_h = N_{1h} \times W_1 + N_{2h} \times W_2$$

where: N_1 = concentration percentage of target group 1;

N_2 = concentration percentage of target group 2;

W_1 = weighting adjustment factor applied to target group 1;

W_2 = weighting adjustment factor applied to target group 2.

As with the single country solution, the weighting adjustment factors and power adjustment could be changed iteratively to deliver the numbers required (see [Chapter 7](#) on Weighting).

Selection of addresses

The number of addresses selected and issued to interviewers in each PSU was set in accordance with the sample design (typically an equal number of addresses were issued in each concentration stratum, aiming to deliver an average of 10 interviews across the stratum). Interviewers had to visit each selected address three times and try to make contact with somebody from the household who could provide details about the persons living there, to determine whether or not any of them would be eligible to take part in the survey. If several eligible persons were identified, interviewers proceeded with randomised selection of person(s) to interview.

If an address register was available for use (the preferred approach), the addresses were selected systematically from the full PSU address listing, so that they were spread across the full area of the PSU.

Random route

Random route approach to selection of households was required in 15 of the 21 EU Member States, using multi-stage area sampling, because it was not possible to access an address register with country of birth information. Here, one or more random starting point(s) were first selected in each of the PSUs (see country reports for the methods used). The country coordinating team centrally determined the number of starting points to select, based on the size of the PSU; if the sampling fraction (number of addresses in the PSU divided by the number of addresses to select) was less than 1 in 20, a single starting point was selected; if 1 in 20–30, two starting points were selected; if 1 in 30–40, three starting points; and, if 1 in 40 or more, four starting points. Where multiple starting points were selected, the number of addresses to contact when proceeding with the random route method from each starting point were divided evenly between the starting points. This was done to ensure coverage of a wider area of larger PSUs by the random route.

Proceeding with the random route approach from the selected starting point, the addresses to contact were then selected as every 'nth' address from the specified starting point, using a standard random route procedure. A pre-determined random route interval was provided for each PSU. The interval n to use in selecting every 'nth' address was set at between 2 and 10, depending on the size of the PSU and the number of addresses to contact (with the objective that the contacted addresses should be spread across the area of the PSU, or as much of it as possible). Due to the screening procedure needed to determine whether households are eligible, the random route sampling procedure was conducted at the same time and by the same interviewer who was responsible for the survey interview.



Rules for random route in EU-MIDIS II

- Office buildings, uninhabited/abandoned housing units, schools, hospitals, public buildings, factories, workshops, supermarkets and shops are excluded from the count.
- Facing the street, with your back to the starting point, you should go to the left. Please ring the doorbell of every nth housing unit in urban PSUs (i.e. houses or apartments; rules concerning rural areas are explained below). When turning at the end of the street, do not stop counting housing units. In the example below, an interval of 5 has been used. We will use this example throughout the instructions. **Your fieldwork manager will inform you of the interval you should use for your PSU.**

16	17	18	19	20	21	22	23	24	25	26	27	28	29	30	31
Start															
1 st contact					2 nd contact					3 rd contact					4 th contact

- At **crossroads**, please turn left. After turning left, keep going on the left pavement till the next crossroads with a right turn. At this crossroad, turn right and keep going on the right pavement. At the third crossroads it is back to the first procedure – turning left and continuing on the left pavement:

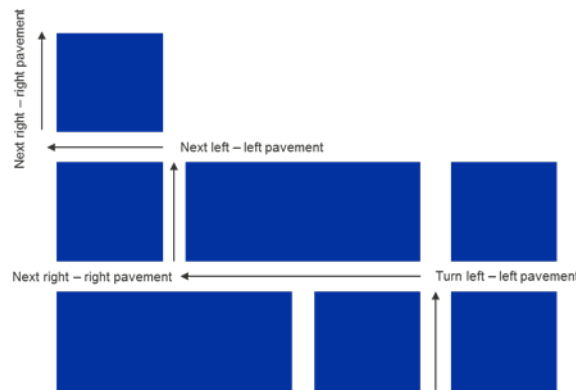

- If there is no other street (e.g. a park or construction site) at the end of the street, then return to the corner of the street where you changed direction and turn left if you previously turned right, or vice versa. The same procedure should be followed when you come to the border of the PSU.

- At a **square or roundabout**, please follow this procedure:

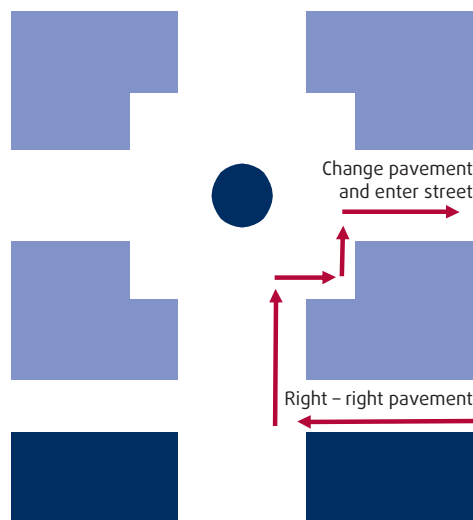

- In the case of **multiple housing units** (e.g. apartments), consider every apartment as a separate housing unit and start at the top of the building, working your way down. You should continue using the same selection interval in multiple apartment buildings.
- If there is **no easy access** to the building (e.g. there is an entryphone/housephone), count the doorbells starting at the top left end and ending at the bottom right. When leaving the apartment building, continue with the first housing unit encountered next to the building.

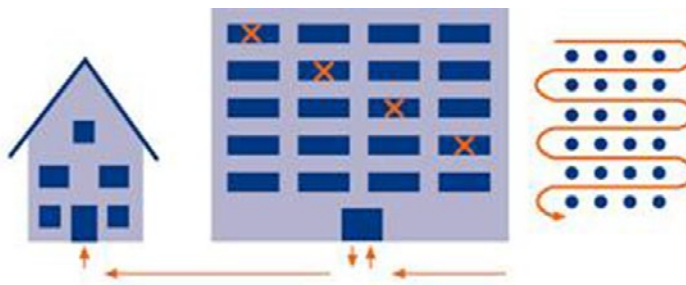

- **Rural settlements** may have a different layout. You should also use whatever interval is advised by your fieldwork manager in these areas. Most typically, they could be simplified as having one of these layouts:

- (1) **Village next to road** – Go to one end of the village and walk to the other end. Choose one pavement and count every three housing units. Arriving at the other end of the village, cross the street and turn around, following the same procedure.



- (2) **Star-shaped village** – There is often an obvious village centre, with several streets leading outwards from the village centre. Start at the central crossroads, selecting a direction and a pavement. Count every three housing units. At the end of the road, cross the street and walk in the opposite direction. At the starting point, take the next street and follow the same procedure.



Counting the interval

Beginning from the starting point address, you should count the interval and visit every n th address. From that address, you should count the interval and call at the next n th address. In streets with both single-occupancy addresses (e.g. 49 and 51 Talbot Road) and multiple-occupancy addresses (Flats 1, 2, 3, 4, 5 and 6 at 53 Talbot Road), the flat numbers should contribute towards counting the sampling interval.



For example, in an urban area, if the last visited address was 49 Talbot Road, the counting interval should include 1) 51 Talbot Road; 2) Flat 1, 53 Talbot Road; 3) Flat 2, 53 Talbot Road; 4) Flat 3, 53 Talbot Road; 5) Flat 4, 53 Talbot Road. Flat 4 at 53 Talbot Road would be the next address to visit.

Usually one dwelling stands for one household. Sometimes several persons live together in one dwelling independently. They share facilities or have separate facilities but they do not share the expenses. For example, three workers who live in the same apartment, paying rent to the landlord, but not sharing any other expenses; or two families living in the same apartment, sharing facilities, but not sharing the expenses. In such cases, you must select the household first. You should list, in alphabetical order, the names of the oldest household members of each household (surname and name). Then you should select the household whose name comes first in alphabetical order.

When you make contact with an occupant at an address, you will need to **identify the correct respondent(s) to interview**, by:

- collecting the details of the eligible household members, and
- using the respondent selection method to select the respondent(s) to be interviewed.

Source: FRA, EU-MIDIS II 2016

Focused enumeration

To increase the efficiency of the screening process, focused enumeration was employed in PSUs with lower estimated concentrations of population (usually below 25 %). This method was originally developed in the United Kingdom, and was already used in EU-MIDIS I as well as in FRA’s Roma survey 2011. Addresses are sampled – from address registers or by random route – in clusters of five neighbouring households. The middle address was designated the ‘core address’ and initial contact initiated at this address. If contact was successful, screening for eligible members of the target group could be conducted by proxy (by asking core address members about country of birth of their neighbours) for the other four addresses in the cluster, always moving two addresses forward and backwards (see Figure 4.1).

If the interviewers were unable to contact anyone from the core address or the proxy screening was unsuccessful (refused or the eligibility of neighbours not known),

the interviewer was required to attempt contact at an FE address and ask the screening questions directly. Proxy screening, however, could be conducted at any of the addresses in the cluster. If eligibility was established by proxy, then the interviewer was to attempt contact, confirm eligibility and attempt an interview.

Although a final screening outcome was required for all addresses, core and FE, the ability to proxy screen meant that in most cases the interviewer would not need to contact all of them directly. This increased the time efficiency of the screening. The interviewer was not permitted to include any addresses outside the clusters in the sample, so the address probabilities were known and the same as they would be without FE.

A section of the contact sheet was used to manage the FE addresses and record outcomes. In address register countries, the additional four addresses around the core address were pre-printed onto the core address contact sheet. In random route countries, the interviewer wrote

Figure 4.1

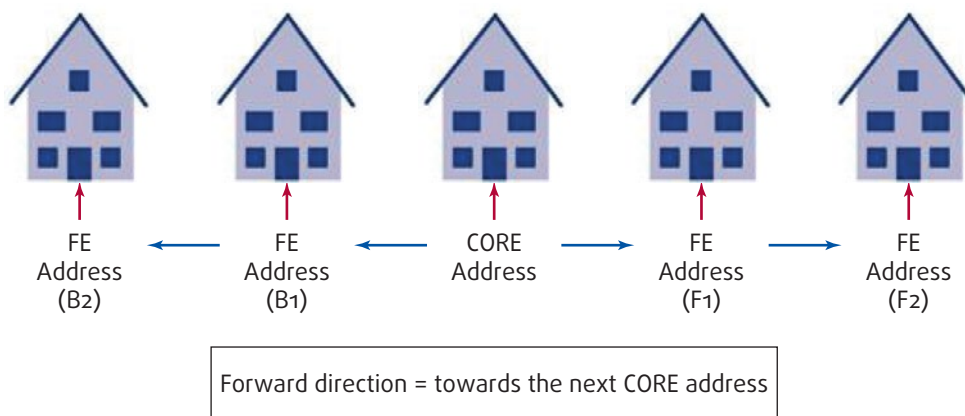

down the exact core and FE addresses on the contact sheet before attempting contact and proxy screening.

In EU-MIDIS II, FE was usually applied in PSUs where the expected concentration of the target group(s) was below 25 %. A larger number of addresses were issued in these PSUs than in PSUs with higher concentration of target groups, so boosting the efficiency of the screening was helpful. Furthermore, the FE procedures required administering five addresses on one contact sheet: the core address plus two FE addresses on either side. FE reduced the quantity of paper interviewers had to carry and manage in less concentrated PSUs. For example, in the least concentrated stratum in Austria, 325 addresses were sampled per PSU, so FE meant that in these PSUs 65 contact sheets needed to be issued instead of 325.

Adaptive cluster sampling

An alternative to FE to increase the efficiency of the screening process is Adaptive Cluster Sampling (ACS). ACS makes the assumption that people from the same target group are more likely to live close to each other (in neighbouring addresses), at least to some degree. Professor Vijay Verma developed ACS to improve the efficiency of screening rare populations and to fully implement the principle of self-identification in data collection. Self-identification is a particularly sensitive issue for Roma, so it was agreed that ACS would be tested for this group. The method was developed and first applied in study on child labour by the International Labour Organization (ILO). The ILO further elaborated

and described it in a book on sampling elusive populations.³⁶ For EU-MIDIS II, the methodology was further developed in close consultation with Professor Verma, who acted as the external senior sampling expert.

The efficiency of FE comes from allowing the interviewer to screen neighbouring addresses by proxy, meaning that they do not need to contact all issued addresses. Unlike ACS, FE's efficiency gains are not dependent on whether or not the target groups live close to each other. When FE was applied in EU-MIDIS II to target groups other than Roma, the screening questions were based on the country of birth and/or country of birth of parents, and not on questions requiring ethnic identification.

The first testing of ACS in the EU-MIDIS II pilot among the Roma target group found ACS to be a potentially promising method for increasing the sampling efficiency for this group. Therefore ACS was adopted for use in the main data collection stage in PSUs with lower estimated concentrations (usually below 25 %) in several of the Roma target group countries (Bulgaria, Croatia, the Czech Republic, Hungary, Romania and Slovakia), as well as in France. FE was not possible in France because legislation forbids recording the ethnicity of another person. Use of ACS was initially also envisaged for the Russian minority groups in the Baltic countries, but the intention to use ACS in Estonia, Latvia and Lithuania was discarded after the pilot suggested ACS as being too complicated.

Figure 4.2: Random route – adaptive cluster sampling (ACS)

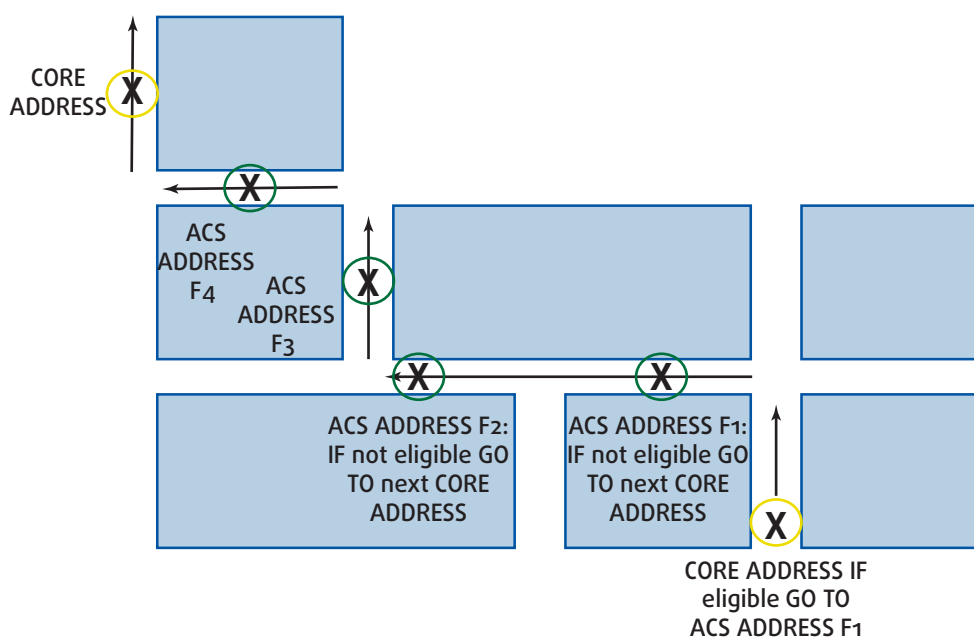

36 See Verma, V. (2014).

Implementing ACS involved issuing a set number of 'core' addresses for contact in PSUs with lower concentrations. The number of core addresses was set at 60 % of the number of addresses that would otherwise be required to deliver the same number of interviews by direct screening. If a core address was found to contain eligible members of the target group(s), the interviewer was instructed to screen the two neighbouring addresses on either side (designated 'ACS' addresses) of the core address for eligible respondents. This 'chain' was continued, by adding further neighbouring addresses in each direction if further eligible households were found. This meant that, where successful, chains of eligible addresses were added to the sample. Chains were ended if the interviewer reached a neighbouring address that did not contain anyone who was eligible, or if eligibility could not be established, or if another core address was reached. However, the chain could continue in the opposite direction from that address. The rules for establishing which addresses were neighbours to those already in the sample were based on the random route rules.

Interviewers could only include addresses in the sample that were either (i) a core address or (ii) a neighbour of an eligible address that had already been included in the sample. Further, interviewers were required to continue screening at neighbouring addresses until the natural termination of the chain, as outlined above. The probability of selection of sample addresses could therefore be determined by the chain length (for further details, see [Chapter 7](#) on Weighting). Records of ACS addresses were kept on contact sheets started for each new core address.

The efficiency gains of ACS result from having to screen fewer addresses for the same number of identified eligible addresses in a PSU as would be identified had ACS not been used. This can be achieved if the proportion of ACS addresses that contain a member of the target group is higher than the proportion in the set of core addresses initially sampled; in other words, if members of the target group tend to live in dwellings which neighbour other members of the target group.

ACS was applied in PSUs where the expected concentration of the target group(s) was below 25 %. In PSUs of higher concentration, ACS was not applied. The rationale for this was that in more concentrated PSUs the fieldwork was already sufficiently efficient, so ACS focused on the PSUs where it was harder to find the target group and the boost to efficiency was most needed.

Difficulties with implementation were encountered in a number of countries, so interviews had to be deleted. There was incorrect application of the rules for ACS – for example, finishing chains too early or continuing a chain even when it had come to an end.

In Bulgaria and Romania, ACS increased efficiency of screening. For example, in PSUs where ACS was applied at core addresses (i.e. every n th address to be contacted on random route), 1,669 contacts resulted in 124 interviews, which is a rate of 7.4 %. For the 550 ACS addresses (i.e. addresses neighbouring a core address with eligible respondents), 251 interviews were obtained, which is a rate of 45.6 %. The core versus ACS address rates in Bulgaria were 13.4 % versus 33.2 %. In Hungary, the rates were the same at 26.9 %. This means that notwithstanding challenges of implementing the procedure, the method can support surveying ethnic minorities through more efficient screening. However, it demands thorough training for interviewers, and some development to ensure rule adherence and field monitoring.

Stopping and dropping rules

Additional mechanisms were put in place to prevent inefficient use of fieldwork resources. As the size of the target group population was often based on rough estimates, EU-MIDIS II adopted rules to account for unexpected fieldwork outcomes at the PSU level. These rules were only applied in exceptional cases, and the decision to apply them was the responsibility of the fieldwork management and not the interviewers themselves.

A PSU could be dropped from the sample (and a replacement issued) if its initial sample outcomes did not meet a minimum threshold of fieldwork success, indicating that the PSU was highly likely to be substantially less concentrated than predicted by the sample frame. The threshold (termed the 'dropping rule') was set at the PSU level. If the probability that the sample frame concentration figure was correct fell below 10 % given the outcomes observed in the early stages of PSU contact, the PSU could be dropped. (The probability was assessed based on the binomial distribution.)³⁷ The dropping rule was set at a level based on the expected concentration of each PSU. For example, with a dropping rule of 16, which equates to a concentration level of 25 %, the rule stated that, if after 16 *successfully* screened addresses all 16 addresses were confirmed as not containing a target group member, then the PSU could be dropped and replaced. To protect against the risk of dropping a highly concentrated PSU too easily, a minimum level of 15 was set for the dropping rule in

³⁷ In probability theory and statistics, the binomial distribution with parameters n and p is the discrete probability distribution of the number of successes in a sequence of n independent yes/no experiments, each of which yields success with probability p . As such, the dropping rule was calculated as n , given an estimated PSU concentration of p , and a 10 % chance that an outcome of n screened addresses with no member of the target group present, keeping the PSU if p was indeed the correct concentration of the PSU, or dropping it if the 10 % chance was not met.

all countries except France, where a level of 10 was set. The individual country reports indicate how often the dropping rule was used.

Fieldwork in a PSU could also be stopped prematurely, i.e. without making all the required contacts at all issued addresses, if a set number of interviews (the ‘stopping rule’) had been achieved. This was set at three times the expected number of interviews in a PSU (factoring in expected eligibility and response rates). This was used to avoid overly large clusters, which could reduce sample efficiency, given that people living in the same area are more likely to resemble each other in other respects compared with people living in different areas. The individual country reports indicate how often the stopping rule was used.

Sampling by referrals

In Germany, an additional sampling step was used to boost the sample coverage. Households were contacted using the onomastic method, the name-based screening strategy. Where an eligible member of the target group was interviewed, they were asked for the contact details of other members of the target group who lived within a 30 km radius. There was no limit on the number of referrals that could be provided, and interviewers recorded up to 30, but the vast majority of respondents provided fewer than 10 referrals when asked.

Fieldwork was completed in full at all addresses identified through the onomastic method before referral fieldwork commenced. The fieldwork managers checked all referral contacts, removed duplicates and provided the contacts to the interviewers. In PSUs where too many referrals had been collected in proportion to the size of the PSU, interviewers were given a random selection of the contacts.

In addition to boosting sample coverage, referrals were also expected to compensate for the potential bias which might be introduced through a fragmented coverage in the initial sample frame of telephone numbers with onomastic screening. Gaps in the onomastic screening might involve, for example:

- i. households that use only mobile telephones and so do not have a phone number listed in the telephone directory;
- ii. households with landlines that choose not to list their telephone numbers in the telephone directory; and
- iii. target group members not identified by the onomastic process because they do not have a common Sub-Saharan African/Turkish surname.

The referral process worked as planned for the sample of immigrants and descendants of immigrants from Turkey, in terms of the number of interviews achieved from referrals. However, referrals provided by immigrants and descendants of immigrants from Sub-Saharan Africa provided too few referrals, so additional onomastic interviews had to be conducted in the same PSUs already selected.

Selection of dwelling units, households and individuals

Interviewers visited the selected addresses and made contact with the household living at the address. On the rare occasions that more than one household lived at an address, one of the households was selected systematically (by listing the surnames of the oldest persons in each household in alphabetical order and selecting the first on the list). Having made contact with a household, the interviewer asked one adult in the household the screening questions to establish the household’s eligibility. If more than one eligible person was living in the household, one or two (if permitted for the target group) of all eligible household members were selected at random for the interview. Interviewers made this within-household selection of respondents using a Kish grid printed on the contact sheet.

Managing fieldwork targets

In each issued PSU, interviewers made the required number of contacts at the full number of selected addresses. In other words, the sample was fully exhausted. The main exceptions to this were PSUs that met the dropping or stopping rule (see earlier in this section), and those deemed unsafe for interviewers to work in. Given the number of sample assumptions that had to be realised to meet the fieldwork targets, and the uncertainties related to some of them (for example, the response rate and adjustments made to target group concentration estimates to account for second generation when using population data which concerned the first generation only), mechanisms were put in place to manage the sample to reach the targets. During fieldwork, the sample was monitored and, once the fieldwork had progressed sufficiently, the final numbers of interviews were predicted based on the emerging response and eligibility rates. It was sometimes necessary to adjust the sample at this stage to ensure the target was reached. Measures taken included issuing reserve PSUs if the sample was predicted to underdeliver, as happened in Ireland and the United Kingdom; reducing the numbers of issued addresses in incomplete or unstarted PSUs if the sample was predicted to overdeliver, as happened in France, Hungary, Portugal, Romania and Spain; or changing the sampling approach altogether, in the Netherlands. In some countries, a higher than expected response rate



offset the effect that lower than expected target group concentrations had on the sample outcomes. This was the case in Belgium, France, Italy and Spain. The country reports provide details of any adjustments made to the sample during fieldwork.

4.7. Location sampling (design 3)

Location sampling or centre based sampling was used in seven EU Member States (Austria, Cyprus, Denmark, Malta, Poland, the Netherlands and Sweden), for one or more target groups in each country and sometimes in combination with one of the sampling methods described earlier in this chapter (see Table 4.12 for details). Location sampling can be used as a probability-based sampling design for dispersed groups which have homogenous characteristics and likelihood of high coverage through various locations and centres. Locations can be manifold places where the target group meets, such as churches, associations and public places, but a register can also count as a location. Location sampling was used in EU-MIDIS II in cases where it was not possible to obtain a sample frame that would allow random sampling of the target group using one of the methods described in earlier sections of this chapter.

The procedures used for location sampling in EU-MIDIS II are based on the methodology described by Baio *et al.* in 2011,³⁸ further developed in consultation with Professor Gian Carlo Blangiardo, a renowned expert on location sampling. Location sampling was implemented in EU-MIDIS II as follows.

Regional mapping, selection of regions and sample allocation

The first step was to obtain regional target group population statistics or estimates on the size and geographical distribution of the target populations, and to identify regions/cities to be included in the sample. In the first instance, the assessment of the geographical distribution of the target group was based on the main regions/cities where the population could be found (largest populations, highest densities), excluding at the outset regions with no or very few members of the target group, and justifying the choice based on the degree of coverage achieved.

It was considered important not to include too many regions because covering a large number of regions in sufficient detail might prove unfeasible, given the preparatory effort and sample sizes per location required. If a region/city was particularly large it might also be necessary to randomly sub-sample/purposively select

lower-level units within it such as municipalities, to ensure that the included areas had sufficient target group populations and that resources were not spread too thinly. In practice, it was usually the case that the largest regions were included and sub-sampling of municipalities was not considered necessary.

Following this approach, target sample sizes were set for each selected region. These were:

- proportional to the size of the target group population in each region; and
- of sufficient size to ensure that adequate number of interviews in each geographically separate region could be included in the sample (the target was a minimum of 30 interviews).

Listing centres in each region

Next, an extensive list of centres that could be included in fieldwork were identified in each region, based on desk research, local knowledge and consulting experts and NGOs and other civil society organisation. The mapping of centres was done based on the following criteria:

- Any locations where people from the target group meet/congregate – these could be welcome centres, marketplaces, places of worship etc.
- The list should be sufficiently heterogeneous to permit encountering diverse members of the target group. For example, it should include locations where women or older people from the target group congregate/meet, as well as locations where men do.
- The list should cover each of the selected regions, incorporating knowledge on the movements of populations. For example, if there are two municipalities and only one has a place of worship relevant to the target group, this could cover both areas.
- The list of locations should be flexible and could be expanded during fieldwork if other important locations were discovered, e.g. by asking members of the target population during the interview which other centres they visited. Extension of the list of centres was completed early in the fieldwork period to minimise the amount of missing information for weighting.
- The objective was to reflect a range of locations which, taken together, increase the chances of the interviewers encountering most members of the target group living in the selected area.

³⁸ Baio, G. *et al.* (2011).

In addition, the importance of each centre was estimated beforehand, broadly measured as the proportion of the target population that visits the centre. Given that this could not be estimated with a high degree of accuracy prior to the survey, the assessment could be based on the known or estimated volumes of eligible people visiting the location per day during the hours of interviewing.

Selection of locations for inclusion in fieldwork

The next step was to decide how many locations were required in each region (set in proportion to sample size and to aim for a minimum of 15 or more interviews at each location) and then select the locations that would be included, out of the longer list of possible venues. The proposal was to carry this out by including all locations assessed as highly important, and taking a random selection of other identified locations. The locations were also selected in view of including a variety of different ‘types’ of centre (e.g. place of worship, shop, etc.) to ensure good representation of the target group. Having selected the locations, target sample sizes were set based on the assessment of the relative importance of each location.

When the location sampling was applied in practice in EU-MIDIS II, however, the plan to sub-sample locations other than those assessed as highly important was not followed through because of constraints on the number of locations available. Further, in most countries, many of the locations initially approached were not cooperative, or were unproductive for interviews because they were not visited by members of the target groups in sufficient numbers. This meant that all locations that could be identified were typically used. Moreover, the minimum target of 15 interviews per location could not always be attained where locations were only marginally productive because few target group members attended. This was the case in Malta and Sweden.

In Austria, Cyprus and Poland, the survey design included the location sampling method, to supplement the sample that could be achieved via one of the ‘conventional’ sampling methods (see [Table 4.12](#)). This was because the target populations in these three countries were particularly dispersed or of especially low concentration. Relying only on the ‘conventional’ sampling methods would have made it difficult to achieve the full target sample size and coverage of the population would also have been very low.

For example, in Austria, setting the address sample frame concentration cut-off for Sub Saharans at 5 % meant covering only 35 % of the population – at this level it would require 20 successfully screened addresses to find one eligible household. Only six Sub

Saharan African interviews were achieved from the conventional sample in Austria, while it was originally estimated that around 50 interviews could be achieved this way. The main reason for this was that the four PSUs with higher estimated target group concentrations turned out not to contain the expected number of immigrants or descendants of immigrants from Sub-Saharan Africa (see country report on Austria for details).

In Denmark, a population register was available for sampling purposes, but immigrants and descendants of immigrants from Sub-Saharan Africa are thinly dispersed across the country. The viability of conducting a part of the interviews with this target group using a register sample was tested in the pilot, which concluded that the register sampling approach would not be successful. Therefore, location sampling was used as the only sampling approach for this group in Denmark.

The fieldwork in the Netherlands was initially planned based on a multi-stage clustered address sample. However, this proved unviable to reach the target sample size when the actual field concentrations of the target group were half of those suggested by the sample frame (17 % actual concentration versus 34 % estimated; see [Table 4.13](#)). The lower than expected eligibility meant that the fieldwork got off to a poor start; interviewers felt discouraged by the amount of screening required, and a number abandoned the project. To complete the fieldwork in the Netherlands, the sampling methodology was therefore changed to location sampling.

The country reports provide specific information on the selection of regions, numbers of locations and location importance estimates. [Chapter 7](#) on Weighting explains how various sampling approaches were taken into account in the development of the weighting scheme for the survey.

Location Sampling was successfully implemented in all countries planned. In practice, however, some problems were encountered:

- The assumption of being able to reach out to the total target population through the selected locations did not hold true in all countries. Women, for example, seem under-represented in such locations, as experienced in Malta.
- The number of interviews carried out at each location should not be too small, to ensure robust estimates of overlaps between locations, which are the basis for weight adjustment.
- Standardisation of procedures across locations and countries is a challenge and preparatory work was sometimes extensive: contacting organisations, pre-screening locations to decide on the selection



process, and tailoring access and interview situations to each location.

- Monitoring of fieldwork at locations was not easy, and it was impossible to carry out back checks with individual respondents because addresses were not linked to the respondents.

4.8. Non-probability sampling (design 4)

In Luxembourg, quota sampling was used because the national authorities did not grant access for EU-MIDIS II to use the national register for sampling purposes. This became apparent at a very late stage, when fieldwork was already ongoing in all countries. Reverting to other random probability sampling methods was not foreseen in the project budget, and would have been difficult to implement on such short notice, so non-probability sampling had to be used.

Regions were selected across the country to ensure a good spread of different areas and to achieve as representative a sample as possible. The target number of interviews for each region was set in proportion to country of birth statistics (which were available at city/commune level). No data were available to inform a probabilistic selection of PSUs, and so they were purposively chosen from among the areas where the target group was known to concentrate.

Interviewers were permitted to move around each selected area, and to approach and interview anyone eligible for the survey provided they filled quotas set on gender and country of birth. The quotas were based on (i) the assumption of a 50/50 distribution by gender – although no statistics were available to assess whether or not this assumption is valid for the target population in Luxembourg – and (ii) available national-level country of birth statistics. No other quotas could be set as further data on the target group were not available.

5

Piloting

This chapter presents a summary of the EU-MIDIS II pilot. It provides a short overview of the approach to the pilot, followed by the key findings, recommendations, and changes made to the fieldwork documents and the project design before the main-stage fieldwork proceeded.

5.1. Methodology

Pilot interviews were carried out in all 28 EU Member States in June–August 2015. Most countries started and finished the pilot during July except Sweden and the United Kingdom, which started pilot fieldwork in June, and Ireland, Italy and the Netherlands, which completed the pilot interviews in August. A total of 467 interviews were conducted at the pilot stage across all countries. This is 18 % fewer than the 570 originally specified in the project’s technical specifications. The difference was due to a change in the pilot testing approach. Initially the plan was for all countries to complete 20 full-length interviews, or 30 in Italy because there are three target groups in this country, using the sampling approach used during the main-stage fieldwork. However, there was some uncertainty regarding the assumptions behind two sampling methods: Adaptive Cluster Sampling (ACS) and Focused Enumeration (FE). Therefore, it was agreed that a selection of countries covering different target groups and sample frames (Austria, Belgium, Bulgaria, Greece, Latvia, Spain and the United Kingdom) would focus on testing both ACS and FE, in place of testing the full questionnaire. In the remaining 21 countries, the full questionnaire was tested. This methodological pilot aimed to test the efficiency of the two sampling approaches (ACS and FE), and therefore resulted in a need for interviewers to visit and screen far more addresses than originally foreseen. This could only be accommodated by cutting the overall number of interviews. In four of these countries

(Belgium, Latvia, Spain and the United Kingdom), interviewers used a short 5-minute questionnaire instead of the full-length version (short paper and pencil interviews (PAPIs) carried out only to give the appearance of a reason for screening respondents). Unlike the full questionnaire, there were no strict targets in place for the number of short 5 minute questionnaires completed per country or per target group, because the focus was on screening as many households as possible to test the sampling approach(es). In most countries, interviewers worked two PSUs, one of which was ACS and the other FE, so that they could contrast the methods. The countries that were to employ address-based sampling methods in the main stage also used ACS alongside their primary sampling method, and in one case FE (Lithuania). Countries had to achieve a minimum of 10 interviews per target group if interviewing two or more target groups, or 20 interviews if they were interviewing just one target group. Apart from the Netherlands and Slovakia, all countries achieved their target number of interviews; however, some countries had to revert to using free-find methods because they exhausted their sample before reaching their target.

Wherever possible, countries applied in the pilot the same sampling methodologies as those planned for their main-stage fieldwork. In countries where the sampling frames were not available in time for the pilot – namely, Finland, Italy, Luxembourg and Slovenia – a free-find approach was used. This method was also used for a part of the pilot sample in Ireland and the Netherlands to achieve the target number of interviews when the main sampling methodology adopted in these two countries did not work as expected and interviewers were unable to reach the expected number of interviews. Although random route was planned in Portugal and Greece, ultimately random selection of addresses was not practicable in these countries. In

Portugal, this was due to a Roma mediator who interfered with household/respondent selection; because of time constraints, Portugal deliberately selected small, concentrated areas within PSUs using local knowledge. In Greece, events surrounding the country's economic crises in 2015 delayed pilot fieldwork, which meant a delayed start to the pilot and insufficient time to apply the method. As a result, addresses were not selected following the random route procedure; however, the within-household selection of individuals to be interviewed followed a randomised process based on the use of the respondent selection grid, as in other countries. Greece used local knowledge/free find to identify PSUs, and Italy used proxy information because sample frame data were not available in time.

Random route sampling was used when piloting the survey in all countries in which Roma were going to be surveyed in the main stage (Bulgaria, Croatia, the Czech Republic, Hungary, Romania, Slovakia and Spain). Exceptions to this were Portugal and Greece, as mentioned above. Random route was also used in countries where Russian minorities were to be surveyed in the main stage (Estonia, Latvia and Lithuania), and in some of the countries where immigrants and descendants of immigrants were to be surveyed (Belgium, Cyprus, France, Greece, Italy, Spain and Portugal). **Address registers** for sampling the pilot respondents were used in the following countries in which immigrants and descendants of immigrants were to be surveyed in the main stage: Austria, Ireland, the Netherlands and the United Kingdom. **Onomastic sample sources** were used in Denmark and Germany, and **location sampling** was used in Austria, Cyprus, Denmark, Malta, Poland and Sweden.

As part of the development of the sample design and methodological improvements implemented, the EU-MIDIS II pilot tested the use of Adaptive Cluster Sampling (ACS) in some primary sampling units (PSUs) to increase the efficiency of the respondent screening process. ACS works on the assumption that people within the same target group are more likely to live close to each other (in neighbouring addresses), at least to some degree. The first EU-MIDIS survey used another approach called Focused Enumeration (FE), which also aims to improve the efficiency of screening minority groups. FE's efficiency gains are not dependent on whether or not the target groups live close to each other, but come from allowing the interviewer to screen neighbouring addresses by proxy – that is, by asking people whether or not any of their neighbours fit the description of the survey's target group and might be eligible to take part. This also means that interviewers do not need to contact all issued addresses. In contrast, ACS does not rely on proxy identification, which for some of the targeted groups in the survey, e.g. Roma, could be particularly sensitive. In addition, ACS allows full implementation of

self-identification without relying on information from proxies. Self-identification is one of the main principles of a human rights-based approach to data – as suggested by the United Nations Human Rights Office of the High Commissioner (OHCHR)³⁹ – which highlights the importance of respect and protection of personal identity as central to human dignity and human rights.

Pilot interviewers and the National Survey Experts (NSEs) provided feedback to the Central Coordination Team concerning the challenges faced in implementing the sampling methods and using survey tools such as the questionnaire and the contact sheet. The Central Coordination Team compiled these comments, which were instrumental for evaluating the need for final changes to the survey methodology and documents before the main-stage fieldwork.

5.2. Key findings, recommendations and action taken as a result of the pilot

The remaining sections of this chapter provide selected key findings, recommendations and actions taken with regard to sampling and the survey fieldwork material, based on the results of the pilot.

Sampling

Key findings: In the pilot, ACS addresses were not found to be more concentrated than core addresses. Five out of the seven countries (Austria, Belgium, Bulgaria, Greece, Latvia, Spain and the United Kingdom) that conducted the methodological pilot had lower concentrations among ACS addresses than among core addresses. In Bulgaria and Latvia, the ACS concentrations were higher in some PSUs and lower in others. Feedback from the pilot also suggested that FE was easier for the interviewers to implement than ACS. Among those testing both options, FE was seen as more efficient and straightforward for interviewers and generated less paperwork. Some of the 21 country teams piloting ACS noted only that a large number of mistakes were made by interviewers when implementing the ACS selection rules. (This was highlighted in Italy, Latvia and Portugal). Some other teams, from the Czech Republic, France and Slovakia, gave positive feedback concerning the use of ACS; their assessment was that the method worked in finding members of the target group and could be applied accurately by interviewers. The Central Coordination Team also examined the way interviewers in various countries had applied

³⁹ OHCHR (2016).

the ACS rules, and found some errors in the way the selection criteria had been used.

Recommendations: Despite challenges related to its implementation, Adaptive cluster sampling was the preferred method for those countries where EU-MIDIS II was to survey Roma, because it lacks the element of third-party (proxy) identification of Roma. Focused enumeration was recommended for sampling of immigrants and descendants of immigrants in countries where the sample would need to cover primary sampling units with a low concentration of the target group. In countries where ACS was to be applied, the pilot results recommended ensuring that this was the only method introduced to the interviewers, to avoid confusion concerning the procedure to follow. It was also recommended that further material and more extensive training covering possible scenarios and procedures needs to be provided to the interviewers. Based on all pilot interviews in the 28 EU Member States, the Central Coordination Team recommended developing the interviewer training sessions further, to include more practical exercises and examples of what to do in specific situations, in implementing both ACS and FE.

Key finding: The pilot suggested that the lack of accuracy of the sample frame – such as the available sampling frame not being fully up to date – could make sampling more difficult in some countries. Much lower concentrations of the target groups were found compared with the sample frame data, for example in pilots carried out in Ireland and in the Netherlands, although the small number of PSUs used in the pilot limited the extent to which definitive conclusions could be drawn concerning the whole country. Furthermore, there was often a lack of viable alternatives to the selected sampling frames.

Recommendations: To plan for a staggered start of the fieldwork where possible, to closely monitor the fieldwork and the validity of the initial assumptions, and to develop contingency plans such as having a reserve sample as well as stopping and dropping rules in place for lower than expected concentration PSUs (that is, rules to determine when interviewers can stop working in PSUs where, after many efforts, they have been unable to find eligible respondents).

Key finding: The PSUs in most of the countries surveying Roma were very large, or the fieldwork teams could not obtain high-quality maps showing the borders of the PSUs prior to the pilot fieldwork. As a result, local knowledge was used to identify Roma settlements and estimate concentrations of Roma in the PSUs prior to fieldwork. Over the course of the pilot fieldwork, some teams found higher concentrations of Roma in the PSUs than expected based on local knowledge. This was the case in Bulgaria, for example. In other countries, e.g. Romania and Spain, initial assumptions

concerning the concentration of Roma proved to be significant overestimates.

Recommendations: For Roma samples, the pilot results suggested that concentrations of Roma should be re-estimated after sample selection, using all available information on the size and location of Roma settlements, so that the correct number of addresses could be issued for each PSU selected.

Key finding: Location sampling was conducted in Austria, Cyprus, Denmark, Sweden, Malta and Poland. The aim of the pilot with respect to location sampling was to test whether or not centres would agree with access and to test the interviewing processes at the centres (random selection of respondents, conducting interviews). Small numbers of centres were chosen purposefully to test within-centre procedures. Location sampling worked well in all countries where it was used and with all groups, except in Poland. All countries found willing participants for the survey, with the exception of Poland, where hardly any immigrants from Vietnam cooperated and immigrants from Ukraine were reluctant. In contrast, Sweden reported that the sole reason for non-participation was lack of time. Regarding respondent selection, specifically when using location sampling, interviewers were recorded as having some problems with following the sampling procedure correctly. The team in Denmark had difficulties using the ‘1 in n’ rule for randomly selecting respondents in pre-selected locations. Austria said that in one (private) venue, eligible people were brought to the interviewers, and the latter were not free to select respondents randomly.

Recommendations: Using a range of closed and public locations can maximise representativeness when relying on location sampling. Fieldwork teams should organise set-up meetings with organisations operating closed venues to obtain their full cooperation. The pilot also highlighted a need for the Central Coordinating Team and FRA to follow up with some country managers to ensure that they understood the details of the location sampling method, and in particular the rules concerning location and respondent selection.

The pilot further recommended that country teams discuss and agree on the most appropriate way of organising interviews in each location, depending on circumstances at the location. This could include location-specific issues such as whether people ‘flow’ through the location during the day or would already be there when interviewers arrive, or both; whether eligible people worked there or were visitors; and what level of help/access the centre could provide for the interviewers to carry out their work. The procedures adopted did not need to be standardised because the main purpose of the random selection in location

sampling is to limit the influence of interviewers over respondent selection by instructing them to follow clear selection rules which ensure that the random selection process is followed.

Gaining respondent cooperation

Key finding: Country teams mentioned notable differences in the level of interest in the survey by gender, target group and education of respondents. Women tended to be less interested in the survey than men (specifically mentioned in Croatia, Finland and France), and in some instances female respondents said that they needed to obtain permission from their husbands to take part in the survey (mentioned in Hungary and Spain).

Recommendations: Wherever possible, gender matching of interviewer and respondent should be applied.

Key finding: In Croatia and Portugal, the pilot fieldwork teams encountered difficulties when working with Roma community mediators or heads of Roma settlements. It was hard to convince them of the need to follow the random sampling rules when selecting the addresses to contact.

Recommendations: The pilot experiences suggested that there was a need for a letter which interviewers can hand to the mediators, and which thanks the mediators for their help while stressing the importance of random sampling. Where NGOs or local community leaders were to be engaged, the importance of random selection of respondents should be explained to avoid conflicts during the mainstage of the fieldwork.

Key finding: There were a number of reasons which respondents gave when they did not want to take part in the survey, such as the length of the interview, no interest in the subject, the fear of possible consequences (such as concern that their answers would be reported to the authorities, especially when questions concern social benefits or residence status), how the data will be used, and refusals due to religious festivals (as the pilot fieldwork fell in the Ramadan period). Respondents were more likely to refuse before the respondent selection was completed, rather than after. Some countries recruited interviewers with the same background as the target groups and confirmed that having a good language match between interviewers and respondents encouraged survey participation.

Recommendations: As far as possible it was recommended that local subcontractors use interviewers with the same background as the target groups. Interviewers should be provided with a list of potential reasons respondents might give for refusal, to help them respond to these arguments and overcome initial refusals.

Key finding: Having the survey material (questionnaire and introductory letter) available in the language of the respondent facilitated engagement and encouraged participation. However, some teams felt that the language of the introductory letter was too complex for some respondents to understand.

Recommendations: It was agreed that countries could tailor the letter to reflect local circumstances, and all tailored versions were to be signed off by FRA before being used in the field in the main-stage fieldwork. A postcard/information leaflet was produced in all national languages to supplement the information provided in the introductory letter.

Contact sheets

Key finding: The pilot indicated the need to redesign the address-based contact sheet to make it easier for interviewers to use, and to ensure that the data collected were complete and accurate. The length and number of contact sheets that had to be completed resulted in some cases in partial and incorrect information being recorded. The need to complete a contact sheet for every screened address (even if ineligible) means that interviewers have to carry a large amount of paper with them at all times. The pilot contact sheets were up to nine pages long. The structure of the contact sheet meant that interviewers had to go back and forth on the sheet to complete sections.

Recommendations: There was a need to reduce the length of the contact sheet, and to make it easier to record non-contacts and non-eligible households, to revise the number of outcome codes, and to reduce ambiguity to make sure that interviewers are able to easily select the correct code. When implementing adaptive cluster sampling, interviewers should open a new contact sheet and add the relevant anonymised household identification number (key), rather than screening ACS addresses on the same contact sheet as the core address. In this way, the original core + ACS contact sheet could be reduced to three pages. The pilot results also called for the Central Coordinating Team and FRA to reconsider the extent to which some information, (e.g. concerning neighbourhood characteristics) is needed. The structure of the contact sheet could be further simplified by moving the respondent selection grid so that it is next to the list of eligible respondents, to make respondent selection easier.

Questionnaire

Key finding: The pilot questionnaire took slightly longer to administer than expected. The average length of an interview was 58 minutes, compared with the expected average length of 50 minutes. Most country teams reported that it was difficult to maintain the



respondents' motivation and interest towards the end of the interview, and in some cases respondents were getting visibly bored or irritated, particularly as parts of the questionnaire were considered very repetitive. As a result, the teams expressed concern that the length and repetitive nature of the questionnaire could have a detrimental impact on data quality and that, once respondents get used to the flow of the survey, they were more likely to deliberately answer 'no' to the discrimination questions to bypass the follow-up questions. A number of questions asked respondents about their experiences in the last five years in their current country of residence. This was a problem for those who had not yet been in the country that long.

Recommendations: Following the pilot, the questionnaire should be shortened by combining repetitive questions to improve the flow of the interview. A potential option was to simplify the timeframes used in various survey questions and to ask only about experiences since respondents had moved to the country, if this had been less than five years ago.

Key finding: Interviewers stated that some respondents became frustrated because, although the survey was introduced as asking about discrimination, the interview started with a lengthy section concerning household composition, which some respondents considered a sensitive subject.

Recommendations: The interviewer training sessions should pay more attention to the sensitive nature of the questions, so that interviewers are prepared to reassure respondents and explain why they were asking certain questions. Interviewers should also be familiar with the definition of a household used in the survey and explain this to the respondent. The introduction at the beginning of the household information section needed revision to ensure that respondents would expect to be asked questions about their household and themselves, but that the main part of the questionnaire would focus on discrimination and other issues. The flow of the questionnaire would be better if some of the questions related to housing and living standards were at the end.

Key finding: Interviewers in Estonia, Germany and Greece reported that the questions concerning employment were sensitive and difficult to answer because respondents were either unsure of their employment status or reluctant to reveal their working situation for fear of reprisal from the authorities. Interviewers in Romania and Slovenia reported that many Roma respondents who were working under irregular conditions were afraid to give an honest answer about their employment situation.

Recommendations: The National Survey Experts should ensure that interviewers understand how to code respondents' various employment situations, and how to probe respondents to ensure that they have captured enough details about their employment situation to perform the coding correctly.

Key finding: A large majority of the country teams (18) reported that asking respondents about their income was very difficult. Respondents were reluctant to answer the questions on income because 1) they felt this question was intrusive, particularly among Roma; 2) they struggled to estimate their income, which might come from a number of different sources; 3) their income was irregular and therefore difficult to estimate on a weekly, monthly or annual basis; 4) they felt embarrassed to say that they were reliant on various benefits as a source of income; or 5) they did not want to include irregular/illicit income.

Recommendations: Interviewers should be reminded to reassure interviewees that information collected in the survey will remain anonymous and be treated confidentially.

Key finding: The teams in four countries (the Czech Republic, Denmark, France and Slovakia) reported that respondents were confused by the term 'married traditionally'. This was among the answer categories when respondents were asked whether they were married, single, etc. They asked if it referred specifically to a marriage in their country of birth.

Recommendations: Interviewers were instructed to clarify what 'traditional marriage' meant. This answer category could also be removed if considered unlikely to provide many responses given the country and the target group in question, while it was kept in the main stage of the survey where relevant.

6

Fieldwork

This chapter provides an overview of the main stage of fieldwork, including a description of fieldwork progress, procedures and outcomes.

6.1. Fieldwork dates and progress

Table 6.1 shows the fieldwork dates, which varied across countries and target groups. All in all, data collection for EU-MIDIS II lasted for almost one year. It started with fieldwork in the United Kingdom at the end of September 2015. Most other countries started fieldwork in October–November 2015. The reasons for different starting times include differences in the amount of time needed to prepare sampling designs and obtain access to existing sampling frames. Countries also differed in terms of the time needed to adapt survey materials in the countries, such as translations, and to prepare the CAPI scripts following the pilot. In some countries, particular events that would have made fieldwork more difficult delayed the start of fieldwork slightly. These included elections in Bulgaria and Croatia, and a high-level summit in Malta. In Luxembourg, the fieldwork did not start until 16 March 2016, after lengthy negotiations with the National Statistical Institute (NSI) concerning access to its register data. Since full access to the register in Luxembourg was not granted, an alternative sample design had to be developed and implemented.

The average time spent in the field to complete the interviews for one target group was 19 weeks. Fieldwork duration varied across countries and ranged from six weeks (Roma in Greece) to 37 weeks (in France). The terrorist attacks in Paris on 13 November 2015 and in Brussels on 22 March 2016 brought a temporary halt to fieldwork in Belgium and France. In some other countries, fieldwork was interrupted because of the need to adjust the sampling approach due to either over-

under-achievement of fieldwork targets. In Finland, for example, interviewers exhausted the issued number of addresses (gross sample) more quickly than expected, and had to obtain an additional sample.

During the course of fieldwork, Ipsos MORI's Central Coordination Team (CCT) provided FRA with weekly updates on the number of completed interviews and other final outcomes. The local project teams were also required to provide fortnightly/periodical updates on response rates achieved by each interviewer, as well as fieldwork outcomes at PSU level. This was done to allow FRA and the CCT to evaluate progress, and to provide early warning of any potential issues with particular interviewers or with the sample design. Each local contractor collected the necessary information independently and presented it to the CCT for review and comment, and for discussion with FRA as necessary.

In addition to these fieldwork progress reports, a teleconference was held with each local contractor, FRA and the CCT during the early stages of fieldwork, to share first experiences of interviewing in the relevant country and to identify potential issues at an early stage. The teleconference covered the following issues:

- check on understanding of the sampling/fieldwork rules and how these were being implemented;
- experience with fieldwork to that point, covering feedback from the interviewers, including with screening respondents and any language, ethical and cultural considerations;
- any challenges faced and discussion on how these could be overcome;
- sharing any best practice tips/examples from other fieldwork agencies.

Table 6.1: Fieldwork dates by country

Country	Fieldwork dates		Dates fieldwork paused (where necessary)	
	Start	End	Start	End
AT	21/10/2015	14/04/2016		
BE	03/11/2015	14/09/2016	13/06/2016	18/08/2016
BG	11/11/2015	20/02/2016		
CY	22/10/2015	05/03/2016	11/01/2016	24/02/2016
CZ	25/11/2015	06/03/2016		
DE	24/10/2015	14/03/2016		
DK (SSAFR)	16/10/2015	26/04/2016		
DK (TUR)	15/01/2016	31/05/2016		
EE	07/12/2015	26/04/2016		
EL (ROMA)	07/11/2015	21/12/2015		
EL (SASIA)	21/11/2015	04/02/2016		
ES	02/11/2015	07/04/2016	12/01/2016	25/02/2016
FI	02/11/2015	09/08/2016	31/03/2016	12/07/2016
FR	06/11/2015	21/11/2016	21/07/2016	14/11/2016
HR	18/11/2015	29/02/2016	23/12/2015	27/01/2016
HU	28/10/2015	13/03/2016	08/02/2016	14/02/2016
IE	26/10/2015	09/05/2016	30/01/2016	13/03/2016
IT	30/10/2015	26/03/2016		
LT	28/11/2015	11/04/2016		
LU	16/03/2016	09/05/2016		
LV	31/10/2015	05/02/2016		
MT	18/11/2015	26/01/2016		
NL	13/01/2016	07/08/2016		
PL	28/11/2015	31/03/2016		
PT	10/11/2015	03/03/2016	23/12/2015	04/01/2016
RO	22/10/2015	18/03/2016		
SE	02/11/2015	30/03/2016		
SI	26/11/2015	04/03/2016		
SK	27/11/2015	29/02/2016		
UK	24/09/2015	24/04/2016		

Source: FRA, EU-MIDIS II 2016



6.2. Contacting respondents – recruitment and interview format

Interviewers working in EU-MIDIS II were required to record the outcome of contacting each sampled address on a contact sheet. Different types of contact sheets were used across the 28 EU Member States. The contact sheets were used as a record of fieldwork progress, and to screen for and select eligible respondents.

Overall, screening based on country of birth – for those interviewing immigrants and descendants of immigrants, including recent immigrants – and on self-identification – for those interviewing Roma or members of Russian minorities – worked well. Respondents were able to understand and easily answer the screening questions. Some countries, such as Austria, reported using a map of Africa when screening for immigrants and descendants of immigrants from Sub-Saharan Africa, as this made it easier for respondents to identify whether or not they are from one of the eligible countries. Croatia and Lithuania were the only two countries that reported respondents being reluctant to self-identify as Roma or Russian minority, respectively.

For the majority of countries where FE was used, there were no reports of difficulties in proxy screening based on country of birth (for those interviewing immigrants and descendants of immigrants) or on Russian minority identity. Only very few interviewers, for example in Greece, reported that some respondents were reluctant to provide information about their neighbours.

Arriving at the selected address, interviewers were required to attempt to make contact with respondents face to face, except in Denmark and Finland, where eligibility screening was by telephone. At least three contact attempts had to be made at all core and ACS addresses before a case could be regarded as a non-contact. In those sampling points where FE was implemented, at least three contact attempts had to be made at each cluster of five addresses – one core and four FE addresses – before any of the cluster of addresses could be regarded as a non-contact.

In Denmark (for immigrants and descendants of immigrants from Turkey) and in Finland, initial contact was by telephone because individual sample frames with telephone contact details were available. At least 10 contact attempts by telephone were required before a case could be regarded as a non-contact.

Contact attempts, face to face or by telephone, had to take place at different times of day and on different days of the week, wherever possible. On making contact, interviewers had to establish whether or not there were any eligible people within the household, randomly select one or two (depending on target group) eligible respondents, and then interview them. Table 6.2 shows the average number of contact attempts in each country.

In location sampling, interviewers made initial contact face to face at the locations. The rules for screening varied depending on the country/location, but in general, interviewers' instructions were to approach every *n*th person as they worked their way through the venue or crossed a person's path in a particular direction. The number of people present determined the sampling interval *n* for each location. If fieldwork took place on days when a location was busier than on other days, the interval was adapted (i.e. shorter interval).

Contact sheets were used to record all screening attempts at both addresses and locations. The location sampling contact sheets were relatively straightforward to complete. However, the contact sheets for addresses were more demanding because of the more complex way of screening for eligibility and recording all necessary information. Few countries included the contact sheets in the CAPI script or scripted the contact sheet on a smartphone app, which was much easier for the interviewers than using paper contact sheets.

All interviews in EU-MIDIS II were administered using CAPI. The only exception from this are some interviews in Portugal, which were conducted using paper questionnaires (PAPI) due to safety concerns over carrying a laptop in certain areas. Six countries – Austria, Denmark, Estonia, Latvia, Lithuania and the Netherlands – also used the CAPI scripts in a language that was tailored to the target group, besides having the CAPI tool scripted in the main national language. In each of these six countries, a minimum of 15 % of productive interviews were carried out in languages tailored to the target group, which indicates that the additional CAPI script translations were a valuable resource (In Estonia, all interviews were conducted in Russian). In other countries, translated paper versions of the questionnaire were used instead to help overcome language problems during an interview. Interviewers used translations most often in Belgium, Germany and Poland. In each of those countries, at least 10 % of the interviews used translated paper questionnaires.

Table 6.2: Contact attempts per issued address by country

Country	Mean	Median	Minimum	Maximum
AT	2	2	1	4
BE	1.5	1	1	8
BG	1.1	1	1	4
CY*	1	1	1	1
CZ	2.2	3	1	4
DE	2	2	1	8
DK**	6.1	5	1	16
EE	2.2	2	1	4
EL	1.3	1	1	4
ES	1.4	1	1	7
FI**	4.4	3	1	15
FR	2.3	2	1	7
HR	1.1	1	1	7
HU	1.2	1	1	5
IE	1.6	1	1	5
IT	1.3	1	1	5
LI	1.5	1	1	4
LV	1.7	1	1	4
NL	1.8	2	1	8
PL	1.5	1	1	8
PT	1.8	2	1	7
RO	1.4	1	1	4
SI	1.6	1	1	8
SK	1.9	1	1	4
UK	2.8	2	1	8

Notes: Information calculated from core and ACS contact sheets, excluding cases with the following outcomes: invalid address, unable to screen – contact not attempted, unprocessed addresses. Productive cases that did not meet quality control requirements were later excluded. Luxembourg, Malta and Sweden are excluded from this table because they did not conduct any address-based interviews; quota sampling was used in Luxembourg, while in Malta and Sweden the survey used location sampling only.

* Interviewers found that they were always able to make contact with someone from the household to complete the screening.

** These include a combination of telephone calls and face-to-face visits.

Source: FRA, EU-MIDIS II 2016



6.3. Interview length

The average interview length was 48 minutes and the median length was 44 minutes. The distribution of interview length shows that interviews varied around the median time, with a tendency for few longer interviews (Figure 6.1). Considering only the first respondent for countries where up to two persons per household could be interviewed, the average interview length

increases to 49 minutes. In other words, interviewers were typically able to complete the second interview in a shorter time than the first. The longer duration of the first interview reflects the time needed to ask a set of questions concerning each household member, which only the first respondent in a household needed to answer.

Figure 6.1: Distribution of interview length in EU-MIDIS II, EU-28

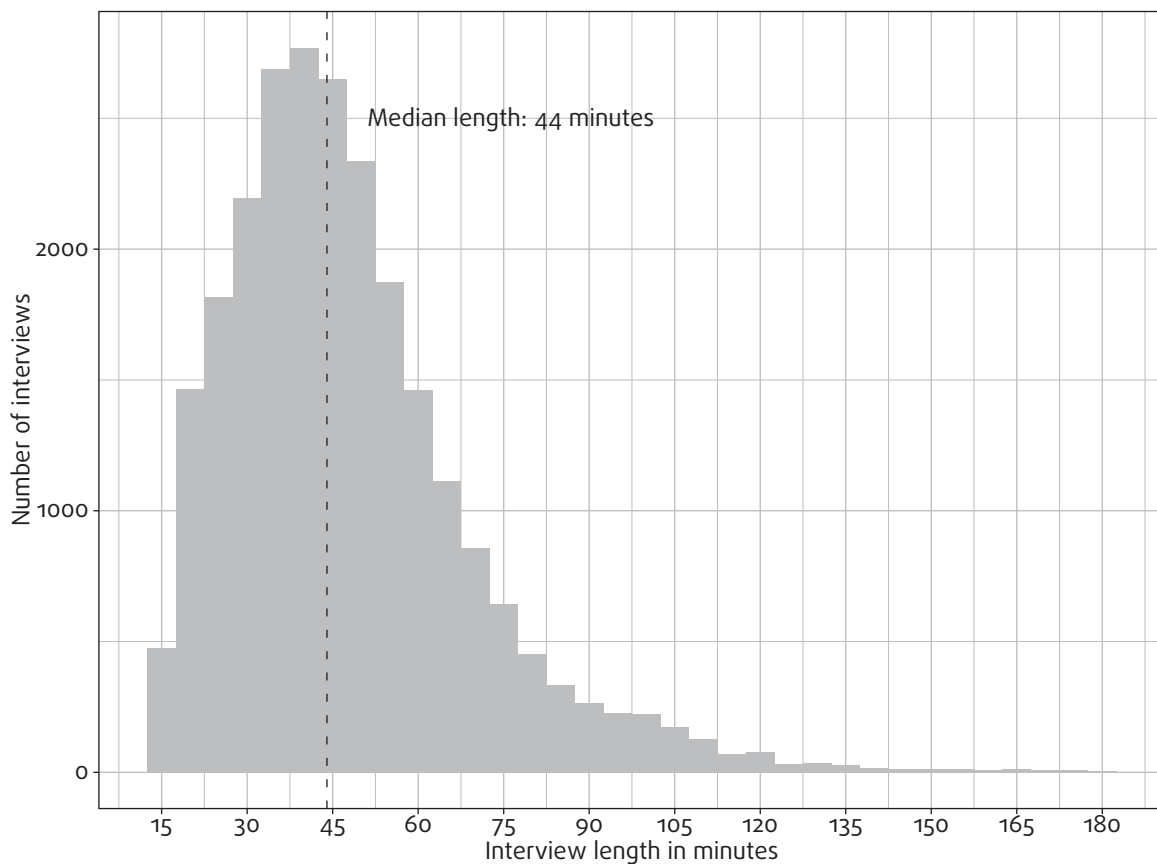

Notes: Statistics concerning the interview length are based on 24,478 interviews. For a small number of interviews, information concerning interview length was not recorded or is otherwise missing/incorrectly recorded. In all countries, some particularly short and particularly long interview times were recorded. These were often due to issues with the timestamp functionality within the CAPI software. For this reason, those interviews that were shorter than 15 minutes or longer than three hours are excluded from the calculations.

Source: FRA, EU-MIDIS II 2016

Figure 6.2 shows the average and median length of interviews by country and target group. Interview length varied quite considerably across the countries. Cyprus recorded the highest average at 92 minutes per interview, followed by interviews with immigrants and descendants of immigrants from Sub-Saharan Africa in Germany (72 minutes) and in Sweden (70 minutes). In contrast, the average interview was much shorter in

Portugal (Roma), Austria (SSAFR) and Lithuania; around 30 minutes. Reasons for these differences include language difficulties, recorded levels of discrimination (respondents who had felt discriminated against were asked follow-up questions concerning their experiences) and household size (due to more information to be provided about household members).

Figure 6.2: Average and median duration of interviews, by country and target group

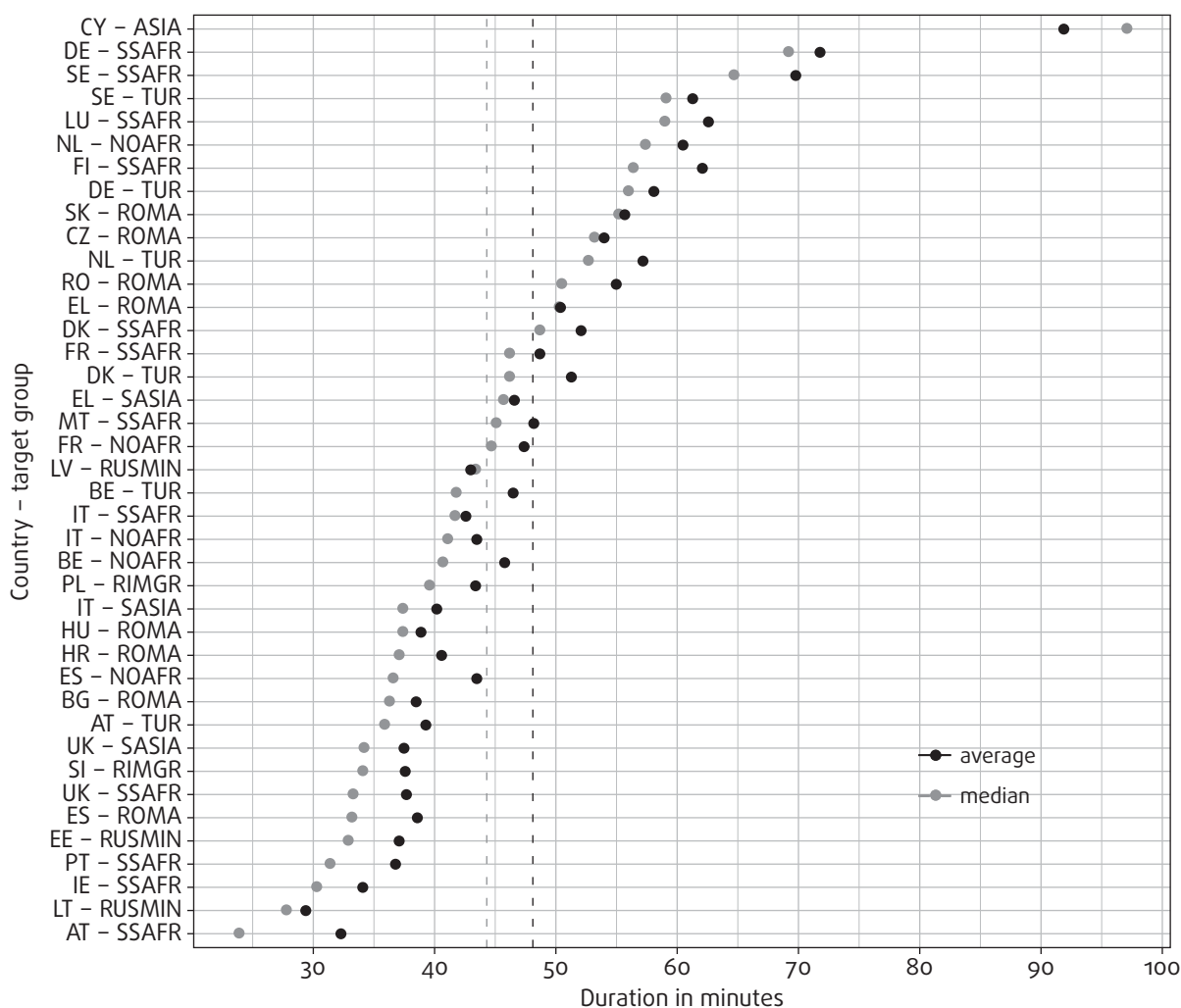

Notes: Statistics concerning the interview length are based on 24,478 interviews. For a small number of interviews, information concerning the interview length was not recorded or is otherwise missing/incorrectly recorded. In all countries, some particularly short and particularly long interview times were recorded. These were often due to issues with the timestamp functionality within the CAPI software. For this reason, those interviews that were shorter than 15 minutes or longer than three hours are excluded from the calculations. In Portugal, 200 interviews with Roma used paper questionnaires instead of CAPI, because of safety concerns, and data entry staff later transferred the data from the paper questionnaires into the CAPI script. As a result, their interview length is much shorter and this group was taken out for calculating interview length.

ASIA, immigrants and descendants of immigrants from Asia; NOAFR, immigrants and descendants of immigrants from North Africa; RIMGR, recent immigrants; ROMA, Roma; RUSMIN, Russian minority; SASIA, immigrants and descendants of immigrants from South Asia; SSAFR, immigrants and descendants of immigrants from Sub-Saharan Africa; TUR, immigrants and descendants of immigrants from Turkey.

Source: FRA, EU-MIDIS II 2016



6.4. Fieldwork support material

A number of fieldwork support material were used as a part of EU-MIDIS II fieldwork, including an introductory letter and a project postcard, respondent-friendly questionnaires and incentives. The introductory letter and postcard contained basic information about the survey, and they were used in almost all 28 countries. Having the letters in alternative languages in addition to the national languages of each country was also useful, although the letters were not available in all target group languages, for example in all Asian and African languages. In several countries, the respondent-friendly paper questionnaires helped the interview process when a respondent's command of the

national language was limited, although in some cases using them reportedly increased the interview length because interviewers frequently had to check that the respondent was looking at the correct page. Table 2.2 lists the languages these materials were translated into.

Many surveys use small incentives as a token of appreciation for respondents, recognising the time and effort taken to complete the survey. In some cases, information about incentives can also encourage hesitant respondents to participate. In EU-MIDIS II, incentives in the form of low value non-monetary gifts, gift vouchers and cash were used in the majority of countries as summarised in Table 6.3. Local teams determined the value of the incentives used in each country, based on their extensive experience. In some countries, the fieldwork teams did not consider incentives necessary.

Table 6.3: Incentives used in EU-MIDIS II

Country	Incentive
AT	Money: € 15
BE	Money: € 10
BG	Double coffee package: value € 2
CY	None
CZ	Money: CZK 35 (€ 1.30)
DE	Money: € 20
DK	Money: € 27
EE	Light reflectors: value € 1
EL	Supermarket voucher: value € 7
ES	Supermarket voucher: value € 10
FI	Voucher: value € 10
FR	None
HR	Gift: value € 3
HU	None
IE	Money: € 10 for one person in household, € 25 for two people in household
IT	Shopping voucher: value € 5
LT	Pens/reflectors: value less than € 1
LU	Money: € 20
LV	Light reflector: value € 1
MT	Money: € 10
NL	Money: € 15
PL	Gifts such as coffee, tea, sweets: value PLN 7 (€ 1.60)
PT	None
RO	Gifts (sweets, coffee): value € 1.65
SE	Supermarket voucher: value € 25
SI	None
SK	Money: € 2
UK	None

Source: FRA, EU-MIDIS II 2016

6.5. Fieldwork outcomes

Table 6.4 provides a summary of fieldwork outcomes by country and the associated response rate. This is at household level and only for address-based samples. This section later describes the exact definitions used to calculate the rates.

The eligibility rates range from only 7 % in Ireland to 100 % in Denmark and Finland. The wide range of eligibility rates and differences between countries and target groups are due to differences in the sampling designs, which targeted different levels of concentration of the target groups. In Ireland, for example, a lot of screening was needed in areas with low concentration of the target group. In Denmark and Finland, on the other hand, the samples used information on the target population from population registers, which resulted in 100 % eligibility of respondents. The response rates vary from 15 % in Denmark and Finland to 90 % in Cyprus. The lower response rate in Denmark and Finland is in part due to the two-phase recruitment approach used, in which respondents were first contacted and screened by telephone to make an appointment for a face-to-face interview.

In addition, feedback from the local contractor in Denmark suggests that there was a higher level of suspicion among immigrants and descendants of immigrants from Turkey contacted about taking part in the survey. Some women were not given permission to take part by their husbands, in particular where it was not possible to arrange for a female interviewer to conduct the interview. Gender matching was used as much as possible, but it was not always possible given the available pool of interviewers and the location of respondents.

However, it was also reported in Finland that there was extensive media coverage of the refugee crisis and related issues, such as immigration, discrimination and racism, before the start of fieldwork and during its first phase, from November 2015 to March 2016. Far-right groups became more active during this time, e.g. patrolling streets and committing arson attacks against reception centres where asylum seekers were living. The fieldwork agency in Finland reported that these events and the general political climate had a negative impact on the willingness of immigrants and descendants of immigrants from Sub-Saharan Africa to take part in the survey. This may also have contributed to a lower response rate in Finland.

The number of **eligible** addresses is based on addresses that were given a final outcome code of:

- Completed interview
- Partial interview
- Eligible but respondent selection refused
- Refusal by contacting field office
- Refusal by selected person before interview
- Refusal by proxy before interview
- No contact with selected person after three visits
- Proxy refusal by someone else at the address
- Broken appointment – no re-contact
- Mentally/physically unable to be interviewed/too ill/sick (during main-stage fieldwork)
- Other unproductive results at known eligible households
- Eligible household – excluded interview (for example because of high item non-response).

The number of **ineligible** addresses is based on addresses that were given a final outcome code of:

- Screened – no eligible household members⁴⁰

The number of addresses with an **unknown** eligibility is based on addresses that were given a final outcome code of:

- Unable to screen because of language difficulties
- Unable to screen because of physical/mental disability
- Refused all information
- No contact made after three visits (includes unable to establish via proxy screening)
- Address issued but contact not attempted (for example where the PSU was stopped).

⁴⁰ This includes FE addresses that were found to be ineligible (either by direct contact, or when screened by proxy).



Table 6.4: Fieldwork outcomes at household level for address-based samples, by country

Country	Ineligible households	Households where eligibility is unknown	Eligible households	Interviewed households*	Eligibility rate (%)	Response rate (%)
AT	4,082	6,133	675	486	14	31
BE	6,902	2,133	1,173	987	15	67
BG	1,206	483	1,377	1,078	53	66
CY	2,212	35	255	233	10	90
CZ	1,022	1,964	2,020	817	66	25
DE	113	1,041	1,473	1,085	93	44
DK	0	1,547	436	289	100	15
EE	92	211	468	401	84	62
EL – ROMA	386	156	791	508	67	57
EL – SASIA	3,081	502	498	399	14	70
ES – NOAFR	8,562	429	798	540	9	65
ES – ROMA	4,882	543	1,282	776	21	56
FI	0	1,037	2,263	502	100	15
FR	4,729	6,118	2,185	1,414	32	34
HR	461	81	591	538	56	85
HU	560	1,200	1,245	1,171	69	56
IE	5,484	826	425	298	7	62
IT	10,485	1,503	1,989	1,145	16	51
LT	3,148	646	572	404	15	60
LV	510	527	973	614	66	47
NL	1,182	2,049	249	209	17	35
PL	206	382	440	272	68	39
PT – ROMA	233	154	674	553	74	70
PT – SSAFR	1,587	284	713	449	31	56
RO	4,244	1,639	1,727	1,408	29	64
SI	2,533	439	389	285	13	64
SK	1,552	1,656	2,147	1,098	58	35
UK	5,763	1,114	1,767	908	23	45

Notes: * Includes only accepted interviews. Interviews excluded because of high item non-response are not counted as accepted interviews, but are included in the number of eligible households.

Luxembourg, Malta and Sweden are excluded from this table because they did not conduct any address-based interviews. Data for Austria, Cyprus, Denmark, the Netherlands and Poland are provided for the address-based part of the sample, while in these countries the remaining part of the sample relied on sampling methods other than address-based sampling.

ROMA, Roma; SASIA, immigrants and descendants of immigrants from South Asia; SSAFR, immigrants and descendants of immigrants from Sub-Saharan Africa.

Source: FRA, EU-MIDIS II 2016

Invalid addresses are those assigned the codes below. They are not included in the response rate calculation:

- Address not valid (does not exist/cannot locate/demolished/under construction/not accessible)
- Address not private (institution/business)
- Address not occupied (empty/second/holiday home).

Interviewed households include only those where at least one interview was completed.

The household eligibility rate *e* is calculated as follows:

$$e = \frac{CEH}{CEH + CIH}$$

where: CEH = confirmed eligible households and CIH = confirmed ineligible households.

The household response rate is calculated as follows, in accordance with the RR3 definition of response rates by the American Association for Public Opinion Research (AAPOR):⁴¹

$$\text{Response rate} = \frac{I}{CEH + e(UE)}$$

where I = interviewed households and UE = households where eligibility is unknown.

6.6. Field force and fieldwork control

Table 6.5 provides details on the number of interviewers who worked on EU-MIDIS II in each country, including information on the percentage of interviews conducted per interviewer and the number of interviewers with the same ethnic background as the target groups. Altogether 1,105 interviewers worked on the project and conducted at least one interview. The number of interviewers per country ranged from 15 to 78. The contractor’s aim was that each interviewer should complete not more than 5 % of the total number of interviews. Table 6.5 shows that in most countries it was not possible to achieve this, and at least one interviewer did more interviews. For all interviewers who did more than 10 % of interviews in a country, a justification had to be provided by the contractor. Reasons for interviewers conducting more than 10 % of the total sample are mainly related to difficulties, in some countries, in finding enough experienced and skilled interviewers ready to work on a challenging project. Where interviewers carried out more than 10 % of the total interviews, additional back checks and quality control measures were put in place to guarantee the quality of the data collected.

It was not possible in all countries to find sufficient numbers of interviewers with the same ethnic background as the target group, because of the level of experience required of interviewers working on the survey.

Table 6.5: Number of interviewers and average percentage of interviews conducted

Country	Number of interviews	Number of interviewers that completed at least one interview	Interviews in the total sample conducted per interviewer				Number of interviewers with same background as target groups
			Mean (%)	Median (%)	Minimum (%)	Maximum (%)	
AT	1,054	31	3	3	1	7	13 Turkish background
BE	1,339	52	2	1	< 0.5	15	1 Turkish background 13 North African background
BG	1,078	59	2	1	< 0.5	5	3 Roma background
CY	436	19	5	4	1	9	2 Asian background
CZ	817	49	2	2	< 0.5	5	5 Roma background
DE	1,419	76	1	1	< 0.5	5	None

⁴¹ AAPOR (2011).

Country	Number of interviews	Number of interviewers that completed at least one interview	Interviews in the total sample conducted per interviewer				Number of interviewers with same background as target groups
			Mean (%)	Median (%)	Minimum (%)	Maximum (%)	
DK	851	51	2	1	< 0.5	8	21 SSAFR background; 20 Turkish background
EE	401	18	6	5	< 0.5	12	12 Russian background
FI	502	23	4	3	< 0.5	12	None
FR	1,640	78	1	1	< 0.5	7	Unknown as ethnicity not captured
EL	1,023	36	3	2	< 0.5	9	None
ES	1,563	50	2	1	< 0.5	7	None
HU	1,171	50	2	2	< 0.5	6	None
HR	538	25	4	3	< 0.5	11	None
IE	425	15	7	8	1	15	2 SSAFR background
IT	1,722	61	2	1	< 0.5	6	None
LV	614	16	6	6	1	12	7 Russian background
LT	404	30	3	3	1	9	2 Russian background
LU	402	18	6	4	< 0.5	14	4 SSAFR background
MT	411	15	7	8	1	10	3 SSAFR background
NL	1,270	34	3	3	< 0.5	6	11 Turkish background 14 NOAFR background 1 Asian background 2 SSAFR background
PL	429	16	6	4	< 0.5	22	2 Ukrainian background
PT	1,078	19	5	3	< 0.5	21	None
RO	1,408	75	1	1	< 0.5	6	None
SE	802	24	4	3	< 0.5	20	9 SSAFR background
SI	404	24	4	4	1	11	None
SK	1,098	75	1	1	< 0.5	5	10 Roma background
UK	1,216	66	2	1	< 0.5	9	4 SSAFR background 10 SASIA background

Note: SASIA, immigrants and descendants of immigrants from South Asia; SSAFR, immigrants and descendants of immigrants from Sub-Saharan Africa.

Source: FRA, EU-MIDIS II 2016

In a number of countries, the local survey companies already had in their roster trained interviewers with the same background as the relevant EU-MIDIS II target group, and with appropriate language skills. In some countries (Belgium, Denmark and Estonia), the local teams went to the effort of recruiting new interviewers and training them specifically for this project. However, many of the newly recruited interviewers struggled with the requirements of the project and resigned. In the Netherlands, the vast majority of the interviewing team was composed of experienced interviewers with Turkish or North African background.

To ensure the quality of the fieldwork, every national agency was required to re-contact a minimum of 10 % of respondents to validate interviewers' work. This process provided the opportunity to confirm that data had been gathered from genuine respondents, that interviews had been conducted correctly, and to assess whether or not the respondent had been left with a good impression of the interviewer and the survey company: Ipsos MORI or the local contractor. Local contractors were required to use one of three methods to carry out these call backs:

- By telephone: respondents who had provided at the end of the interview a telephone number for quality control purposes were contacted by a member of the validation team and asked to confirm selected details of their interviews.
- By post: cards with return postage paid were sent to the respondents, asking them to confirm selected demographic and survey details.
- By personal visit: a supervisor visited the respondent's address and asked them to confirm selected details of the interview. The interviewer was asked to accompany the supervisor in case there were queries.

Countries using random route were also required to check that the procedures had been followed correctly and that the correct addresses had been selected. If problems were detected, national agencies were required to increase the number of checks carried out. Where serious problems were identified with the quality of an interviewer's work, the interviewer in question was removed from the project, and their interviews were excluded from the final data. In less serious cases, interviewers were re-briefed to prevent future errors.

6.7. Data processing and data cleaning

Nine countries used Dimensions software for their questionnaire script, which was programmed centrally by the

Central Coordination Team (CCT) of the survey contractor – specifically their data processing team in the United Kingdom – while other countries programmed the script using other software. Countries using software other than Dimensions were required to submit their data in ASCII format, based on a standardised data map. In preparation for the main data delivery, interim data were requested after 10 %, 60 % and 100 % of interviews had been completed. After each interim delivery, the data were checked for routing errors. Where errors were detected, countries were asked to amend their scripts and re-contact any respondents that might not have been asked a question that they should have had the instructions of the questionnaire been followed correctly. The local contractors were also required to check the quality of their data on a regular basis. To ensure the quality of the data, the CCT wrote the checking syntax centrally for the statistical programme SPSS, and distributed it to countries to run on their data before submission. The syntax converted the ASCII data into SPSS format and then checked that:

- the data matched the data map;
- the ID numbers were unique and there were no duplicate records (unless there were two interviews in the same household);
- the routing had been adhered to;
- only permitted values had been entered;
- the household grid and demographic information did not contain any inconsistencies ('sense check').

All countries were required to check their data using this syntax and amend accordingly. Firstly, countries were required to go back to their raw data files to check if any mistakes were processing errors which might have occurred when data were transferred from one file or format to another. If this was not the source of the detected error, countries were instructed to raise the issue with the interviewer who had administered the questionnaire. If any data were missing, the respondent would be re-contacted to collect the missing information.

Once the data were submitted to the CCT, the checks were re-run to ensure that there were no outstanding errors. In addition to the checking syntax, any very short or very long interviews, as well as interviews with high levels of item non-response were investigated. The CCT also ensured that every interview could be matched to the associated contact sheet.

The questionnaire contained a number of questions with an 'other – specify' response code. Where a respondent selected this option, their verbatim response was



captured (open text). During data processing, these responses were translated into English, and these were back coded into the existing code frame where possible. In some instances, the back coding prompted follow-up questions that had been skipped during the interview on the basis of the initial coding of the response. In these cases, the data in the follow-up questions are recorded as missing.

Data from all 28 EU Member States were combined into a single data file. In this process, the country-specific questions needed to be harmonised into a single variable to allow for comparison. This included all education and income questions. To minimise the size of the dataset, it was also agreed that country-specific questions regarding the Equality Bodies would not be included. Instead, these are harmonised, and the codebook can be used as a reference to determine which Equality Body is being referred to in each country. The same approach was also taken for recording a respondent's level of comprehension of the country's national language and the frequency of attending selected locations for countries using location sampling.

Interviews with a high level of item non-response were excluded from the final dataset. For EU-MIDIS II, a high

level of item non-response was defined as interviews where more than 50 % of the questions asked were answered with 'Do not know', 'Refused' or 'Does not understand the question'. In addition, any interview which had between 25 % and 50 % item non-response, and did not have an answer to a key variable which would be used to develop important indicators, was also excluded from the final dataset. The list of important indicators was defined separately for the target groups 'Roma', 'Russian minority' and 'immigrants and descendants of immigrants'.

Data from the contact sheets were checked as well for correctness and if they matched correctly the cases in the main dataset. For countries using Focused Enumeration and Adaptive Cluster Sampling, additional checks of the contact sheet data were made by the CCT and FRA.

Due to the higher levels of missing data on income and the importance of having information on household income as well as age and gender for all household members for calculating social inclusion indicators, missing data for the exact household income have been imputed using standard methods of imputation.⁴²

⁴² Data imputation means that values were inserted for missing data.

7

Weighting

This chapter describes the weighting approaches applied to the EU-MIDIS II dataset. Weighting is necessary to adjust the statistics produced in accordance with the sample selection process, and to correct for potential deficiencies due to non-response. The weighting approaches for EU-MIDIS II took account of the sample design for each country. See [Chapter 4](#) on Sampling, for a description of the sampling designs.

7.1. Weighting procedures: clustered and unclustered samples (sample designs 1 and 2)

This weighting approach was applied in the majority of countries. Three types of weights were used to weight these samples:

- 1) design weights;
- 2) non-response weights; and
- 3) post-stratification weights.

Design weights

Design weights were required to equalise differential selection probabilities arising from the sample design. On the EU-MIDIS II samples, this could occur at any of the following stages:

1. PSU selection;
2. address or individual selection;
3. dwelling unit and/or household selection;

4. respondent selection; and
5. respondent referral, in Germany only, where respondents were also recruited through referrals.

The probabilities calculated at each stage were multiplied to provide the overall probability of inclusion for each case in the sample, and the design weights were calculated as the inverse of this probability. In countries with multiple target groups sampled together, the target group membership was ignored at the design weighting stage.

PSU selection (clustered samples)

In most countries, differential selection probabilities applied across target group concentration strata, as strata with higher concentration of the target groups were oversampled. The probability of selection was recorded at the PSU selection stage so that it could be corrected. [Table 4.13](#) reports the impact on precision from this stage of weighting.

In most countries, PSUs were selected with PPS. See [Table 4.13](#) for the method used, by country. This resulted in addresses being selected with equal probability *within concentration strata*, when equal numbers of addresses were selected at the next stage.

For samples based on addresses, the PPS size measure would ideally be the total number of addresses belonging to the members of the target group within each PSU. In some countries, it would be the number of households or families. Where this was not available, the total population size was used instead. Samples drawn from individual registers used the total target population size as the PPS size measure. The weight adjustment was based on the PSU size measure used for selection, i.e. the actual probability of selection,

irrespective of whether or not this was the ideal measure (e.g. addresses).

The probability of selection of a PSU at this stage was:

$$\text{PSU selection probability} = \frac{N \text{PSU}_h \times \text{size PSU}}{\sum \text{size PSU}_h}$$

where $N \text{PSU}_h$ = number of PSUs selected in concentration stratum h , size PSU = size of the PSU selected and $\sum \text{size PSU}_h$ = sum of sizes of all PSUs in concentration stratum h .

The PSU selection weight (DW_{PSU}) was the reciprocal of its probability.

Address or individual selection within PSUs (clustered samples)

In the clustered samples, addresses had different selection probabilities across PSUs, given that the PSUs are of different sizes. The numbers of addresses selected were designed to deliver similar numbers of interviews in each PSU. The probability of selection of each address (conditional on selection of its PSU) was:

$$\text{Address or individual selection probability} = \frac{\text{Number of addresses selected}}{\text{Number of addresses in the PSU}}$$

Where the number of addresses (or households or families) in the PSU was not available the number was estimated. This was typically based on survey data on the size of households at an appropriate level of aggregation (concentration strata, regions, rurality), checked against population data. Survey data were considered (and not just population statistics) because most of the target groups live in households larger than the country average.

The address or individual selection weight (DW_{UNIT}) was the reciprocal of its probability.

Further adjustments for focused enumeration (FE) and adaptive cluster sampling (ACS)

No additional adjustment was required in PSUs where focused enumeration was used as a sampling method; the number of addresses selected and used in the probability calculation included both core (centre) and focused enumeration (two neighbours either side of the core) addresses. Hence, the sample address selection weight, DW_{UNIT} , was based on all addresses in FE PSUs.

For ACS further adjustments were required. Firstly, at the address-selection stage, fewer addresses were selected (than would be needed for the same number of interviews without ACS) and additional addresses were added in accordance with the ACS procedures. The probability of selection of the initial set of (core) addresses was therefore based on the number initially selected.

Additionally, in theory any address in an ACS chain of neighbouring eligible addresses would be included in the sample if any one of the addresses in the chain was initially selected, as the addresses neighbouring an eligible address are added to the sample. Therefore, the probability of selection of all addresses in ACS PSUs, whether selected at the start or through association with other eligible addresses, could be considered to be in proportion to the number of addresses in the chain. For example, an address which neighboured one other eligible address had twice the chance of selection as an eligible address on its own; addresses in chains of three eligible addresses had triple the single eligible address selection probability; and so on.

This conclusion, however, depends on two assumptions: 1) that all addresses are successfully screened for eligibility and 2) that the chain size is not capped. In reality, many addresses were not successfully screened for eligibility, and the approach meant that a chain with a sequence of outcomes of 0011100 received the same weight as one of XX111XX (where X = no information available; 0 = ineligible household; 1 = eligible household). Furthermore, the full length of the chains was not always established if the fieldwork was stopped in the PSU upon reaching the set maximum number of interviews (see stopping rule description in Section 4.4). In practice, the second issue, capping, occurred very rarely, so it is unlikely to have had any impact on the weighted survey estimates.

Following on from this discussion, the probability of selection of an address in ACS PSUs was:

$$\begin{aligned} \text{ACS address selection probability} = & \left(\frac{\text{Number of addresses initially selected in PSU}}{\text{Number of addresses in the PSU}} \right) \\ & \times \text{Number of eligible addresses in its chain} \end{aligned}$$

The ACS PSU address selection weight ($DW_{\text{UNIT_ACS}}$) was the reciprocal of its probability.

Note that further capping of ACS chain lengths was considered at the weighting stage, to limit the impact on the efficiency of the sample, but the final chain lengths were not long enough to warrant it.



Household selection (individual register samples)

In the countries using individual-level registers one of two selection approaches was used in the field:

1. The individual named on the register sample was treated as the sampled unit and only this person was interviewed (if eligible); or
2. The household (that the named individual resided in) was treated as the sampled unit and up to two individuals living in that household were randomly selected for the interview out of all eligible individuals, even if this resulted in not selecting the named individual.

The first procedure required no further weighting at this stage.

For the second procedure, because it could not be ascertained in advance which individuals on the sample belonged to the same households, the probability of selection of households varied according to the number of eligible individuals within them and required further weighting. This was equal to (conditional on selection of a household member):

Number of eligible people in the household.

The household selection weight for individual register samples (DW_{UNIT_IND}) was the reciprocal of its probability. In samples that were both clustered and from an individual register (as in Slovenia), this weight was additional to the DW_{UNIT} weight.

Dwelling unit (clustered samples)

If an interviewer discovered in the field that an issued address was made up of multiple dwelling units, they selected one dwelling unit randomly. The probability of selection of a dwelling unit (conditional on selection of its address) was:

$$\text{Dwelling unit selection probability} = \frac{1}{\text{Number of dwelling units or households at the address}}$$

Random selection of dwelling units was only required for address register samples (because the random route procedures identify unique addresses at the outset). Similarly, random household selection was not required for individual registers because the selected individual could belong to only one household.

The dwelling unit (DW_{DU}) selection weight was the reciprocal of its probability.

Weight for referrals (used in Germany)

In Germany, an additional weight was added to account for the probability of selection of referral addresses. The probability of selection of each referral address was based on the total network size (number of referrals provided by each initial sampled address) and the number of referral cases selected:

$$\text{Probability of selection of each referral address} = \frac{\text{Referral cases selected}}{\text{Referral cases provided (size of network)}}$$

The referral selection weight (DW_{IND_R}) was the reciprocal of its probability. This weight was applied to referral cases after application of the full set of weights up to this stage. This included PSU selection, address selection – see above – and household non-response weight, described below.

Individual respondent selection

Whenever a household contained more eligible individuals than the survey protocols permitted for interview, the interviewer selected the allowed number of individuals randomly (i.e. one for Roma and Russian minority target groups and two for all other target groups). The probability of a respondent being selected (conditional on selection of their household) was:

$$\text{Probability of respondent being selected} = \frac{1 \text{ (Roma/Russian minority) or } 2 \text{ (all others)}}{\text{Number of eligible people in the household}}$$

The individual selection weight (DW_{IND}) was the reciprocal of its probability.

Non-response weights

Non-response weighting relies on having information at respondent or address level that covers both responders and non-responders. This is usually obtained from the sample frame, and in some countries where population registers were used to make contact with sampled individuals directly, this approach was considered. In Finland, however, demographic variables were not obtained from the register and therefore an additional adjustment was not possible. In the absence of sample frame information the details can be collected by interviewers in the field, which was the approach used for most of the EU-MIDIS II samples. On EU-MIDIS II, this approach was employed due to the lack of demographic population data covering the target group that

could be used for post-stratification weighting (the final weighting step) – and so estimating and correcting for non-response from the sample frame was important.

Non-response weighting involved the following steps:

1. Neighbourhood characteristics (recorded on the contact sheet) were used to correct non-response by households, conditional on household target group eligibility; and
2. selected respondent characteristics (recorded on the contact sheet) were used to correct for nonresponse by individuals, conditional on their selection for an interview.

The weights were calculated in separate stages, first household nonresponse weights (NRW_{HH}), where the household-level achieved sample was weighted to the neighbourhood characteristics of the overall issued and *confirmed eligible* sample, after applying the design weights up to the household selection stage ($DW_{PSU} \times [DW_{UNIT} \text{ or } DW_{UNIT_ACS}] \times [DW_{UNIT_IND}] \times DW_{DU} \times DW_{HH}$).

Following this, individual nonresponse weights were calculated (NRW_{IND}), by weighting the individual-level data to the respondent characteristics of all selected individuals, after applying the full sequence of applicable weights up to that stage ($DW_{PSU} \times [DW_{UNIT} \text{ or } DW_{UNIT_ACS}] \times [DW_{UNIT_IND}] \times DW_{DU} \times DW_{HH} \times NRW_{HH} \times DW_{IND}$).

Both forms of weights used logistic regression to fit a model with response to the survey (as a binary variable) as the dependent variable. The weight was calculated as the reciprocal of the probability of response generated by the model.

Post-stratification or calibration (individual and household) and final weights

The last stage of in-country weighting was to weight the individual-level data to the population profile of the covered target group. This stage aimed to correct for remaining deficiencies due to non-response not already corrected by the non-response weighting.

Post-stratification or calibration weighting adjustments depend on reliable population data covering the survey population. The challenge for EU-MIDIS II was that, because the target groups typically made up a small proportion of the overall country populations, profile data from other surveys could not be used (due to small sample sizes). Moreover, in most countries EU-MIDIS II did not cover the full target group population in the country. That complicated it further.

Therefore, the variables that were used in the post-stratification were taken from the EU-MIDIS II country sample frames, specifically region and urbanisation. These were available for all countries, including the values of interlocking cells. The weighting profiles were based on the *covered* target group, rather than also attempting to use the weighting to correct for coverage. This approach was taken because weights are not able to ‘correct’ for gaps in the sample where there are no similar cases that can be used to represent those that are missing.

Post-stratification weights were calculated for each target group separately, after applying the full set of applicable design/non-response weights described above. The calculation used cell weighting. The weights that were applied at this stage were gross population weights, based on the *covered* target group population of *all ages*,⁴³ so that weighted sample estimates took the same total value as the total size of the covered target group population in each country. This means that a single weight can be used for any within- or cross-country analyses that may be required. This **final individual weight** was applied to the interviewed cases.

Given that other information potentially used for post-stratification, such as gender and age structures, was not (easily) available for the covered target population, no adjustments for gender and age were made in this phase for most countries (but in the early non-response adjustment). The exceptions were **Finland** and **the Netherlands**. There, additional adjustments were made using available demographic variables. Evaluations were undertaken for these samples due to concerns with the sampling and because there were statistics available to make comparisons. Specifically, in Finland there were coverage losses because most individuals sampled could not be matched with a telephone number. In the Netherlands the sample design was changed to location sampling part-way through fieldwork and the full address sample was not realised.

These samples were adjusted to population characteristics taken from the population register and based

43 Estimates of the size of the covered population were taken directly from the sample frames; see Table 4.11 in Section 4.3 for a list of data sources. The post-stratification population targets were based on the population of all ages, rather than adults, because data were available at this level for the majority of countries. In a handful of countries, the population figures available were for adults only; in these instances, the figures have been inflated based on the survey data (number of children in household). A similar procedure was used to inflate first generation target group population figures to include second generation where this was necessary. Particularly in Cyprus, the proportion of citizens of Cyprus in the survey data was used to inflate the citizenship figures provided in the sample frame. Similarly, in Poland the sample frame figures were inflated by the proportion of non-registered immigrants in the survey data.

on the covered population (Finland) or a combination of the covered and total population depending on data availability (the Netherlands). The following variables were used:

- Finland: NUTS3, age (in four bands) and gender (all to covered population totals);
- Netherlands: NUTS3 (to covered population totals); and generation (first or second), country of origin for immigrants and descendants of immigrants from North Africa (Morocco or other), age (in five bands) and gender (demographics to 16 + total target group population proportions).

The raking calibration weighting procedure was applied using the statistical software package Quantum. For both countries the adjustment was made to the full design-weighted samples.

A further weight was calculated, the **final household weight**, to be used for analyses based on all cases in each household (which were provided in the final dataset). This weight was calculated as the final individual weight divided by the number of people (of all ages) in each household. This meant that the weight was consistent with the individual weight, and weighted analyses based on either weight add up to the covered target group population of each country. This weight was applied to each case in the dataset (one case per household member, whether interviewed or not).

Trimming weights

The weighting procedures resulted in large variations between weights. Large weights can result in substantial losses in sample efficiency, so it is common practice to trim weights. Weights were therefore trimmed at several stages during the weighting. Broadly, the following trimming was considered:

- The full address selection weight (PSU and address unit selection weights combined) was usually trimmed at the 5th and 95th percentiles of the distribution. This was the maximum level of trimming applied. Less trimming was applied if the difference between the smallest and largest weight was within 10, or could be brought within 10 by a smaller amount of trimming, or if no trimming was required to reach this level.
- The individual selection weight was always trimmed at the 97.5th percentile.
- The address referral weight (for the sample in Germany) was trimmed at the 95th percentile.

- The post-stratification weighting adjustment cells were capped to the next-nearest weight if outliers were observed.
- The final individual weight was trimmed at the 99th percentile (after applying post-stratification weights).
- Location sampling weights were trimmed if outliers were observed (by setting the weight for the location to the size of the next largest weight).

This iterative process was used as it means that the effect of later stages of weighting is retained in the sample. If all trimming were at the end, this would disproportionately affect certain cases, e.g. those that were initially sampled at a lower rate because they were in less concentrated strata.

7.2. Weighting procedures – location sampling (sample design 3)

The weighting strategy for the location sample followed the approach described in the paper by Baio *et al.* (2011).⁴⁴ For countries that included more than one city or region (all countries where location sampling was used, except Malta), the weights were generated separately for each region and then adjusted to be in proportion to the size of the target population when the regions were combined. This is a requirement of the method; if several cities were included in a single weighting scheme, the estimates of importance of the locations would be too low in some regions/locations, as it would be uncommon for members of the population to visit locations across multiple cities. The method requires a certain amount of overlap of members visiting different locations, which warranted treating each region separately.

In weighting, the locations were considered not as single specific locations, but rather types of location. For example, rather than considering each religious centre in a region separately, they were treated as a single entity. This is consistent with the approach described in the Baio *et al.* (2011) paper,⁴⁵ and has the advantage of increasing the sample sizes and so gives more precise estimates of attendance to be used for the weighting.

For each region/country, the baseline location was defined to be the location that was visited by the highest proportion of the eligible population. In most cases, one location dominated, so this decision was clear cut.

⁴⁴ Gianluca Baio, G. *et al.* (2011), pp. 451–465.

⁴⁵ *Ibid.*

For others, the location that appeared most important was selected initially and then a measure of relative importance was calculated and checked for each location (r_k ; see calculations for locations) – this usually confirmed the choice of the baseline location. In a few cases, the measure of relative importance indicated that an alternative location should be defined as the baseline, and in these cases the baseline location was changed to that identified as the most important.

In countries where a register or clustered address sample was used to select some of the sample (and therefore a combined approach used), the register/address sample was defined to be the baseline location, and participants sampled at locations were asked where they lived so that it could be determined whether they could have been sampled from the register. In Poland, an additional question on whether respondents have a permit to stay in the country was used to identify participants sampled at locations who could not have been sampled from the register which does not include persons without a permit. The full set of weights were applied to the register/address component of the samples before the location sampling weighting steps described below; this applied in Cyprus and Poland.

In the Netherlands this approach was not used, because location sampling was added partway through fieldwork and, in spite of additional efforts to re-contact sample members, location visit information was not available for enough of the register sample. Instead, the location sampling and address sampling components of the Netherlands sample were weighted separately and combined in proportion to their respective sample sizes before the final calibration weighting stage.

Calculations for locations

Using the same notation as in Baio *et al.* (2011),⁴⁶ the following were estimated for each location k :

1. The proportion of respondents at the baseline location that also visited location k :

$$A_k = n_{\text{baseline that also visited } k} / n_{\text{baseline}}$$

(Note that, when a register was the baseline location, then A_k was estimated based on a weighted register sample to obtain unbiased estimates.)

2. The proportion of respondents at each location that also visited the baseline location:

$$B_k = n_{k \text{ that also visited baseline}} / n_k$$

3. The ratio (r_k) of A_k to B_k :

$$r_k = A_k / B_k$$

This is the survey-based estimate of the relative prevalence of visits to location k compared with the baseline. It can be considered to be a measure of the relative importance of each location k compared with the baseline location. A measure of r_k greater than 1 implied that location k was more important than the baseline location. The estimates of r_k were used to test that the most important location had been selected as the baseline. If another location was identified as the most important ($r_k > 1$), then it was re-defined as the baseline location and the steps above were repeated.

4. The proportion of interviews carried out at location k :

$$\theta_k = n_k / n_{\text{all interviews}}$$

5. A measure of how over- or under-represented each location was:

$$\delta_k = \theta_k / r_k$$

If a location has a value of δ_k that is greater than that of the baseline location, it implies that more interviews were carried out at that location than would be required based solely on its relative importance. Conversely, if the value of δ_k is less than that of the baseline location, it implies that fewer interviews were carried out at that location than would be required based solely on its relative importance.

For some locations, due to small sample sizes or there being little or no overlap with the baseline location, there was an extreme value of δ (e.g. zero if no overlap). If left unamended, this would have resulted in extreme weights, which would have reduced the efficiency of the sample. To avoid this, extreme values of δ were trimmed to the next largest estimate for high values or to the next lowest estimate for small values.

Individual weight

If a participant only visited one location (e.g. location s), then their weight is calculated to be:

$$\text{weight} = 1 / \delta_s$$

That means that a participant who visited a location that was under-represented compared with the baseline location would be given a higher weight relative to the baseline location. This is consistent with what could be expected for the weights.

⁴⁶ *Ibid.*



The weight for a participant who visited more than one location (e.g. locations s , t and u) is calculated from the corresponding values of δ as:

$$\text{weight} = 1/(\delta_s + \delta_t + \delta_u)$$

This means that a participant who visited more than one location is given a lower weight than a participant who visited only one of them. This again is consistent with what can be expected for the weights and acknowledges the increased likelihood of participation of that participant.

In general, the formula for the weights for each participant was calculated as:

$$\text{weight} = 1/\sum (C_i \times \delta_i)$$

where $C_i = 1$ if the participant visited location i , and otherwise 0.

Before finalising the weights they were checked to make sure the weights had no extreme values, which would reduce the efficiency of the sample. All small weights were trimmed to the next highest value and any large weights to the next smallest value, so that the largest weight was not more than approximately 10 times larger than the smallest one.

Post-stratification weight

Post-stratification weights were calculated for each target group separately, after applying the location sampling weight described above. The calculation used cell weighting. As with the other samples, the post-stratification weights were to the size of the target group population at region level, and were based on the covered target group population of all ages (i.e. if some but not all of the regions of a country were included in the sample, the control totals included the target group population sizes of covered regions only). This **final individual weight** was applied to the interviewed cases. The combined location/address sample in the Netherlands was weighted using calibration weighting to available demographic variables.

As with the other samples, a **final household weight** was also calculated to be used for analyses based on all individuals in each household (which were provided in the final dataset). This weight was calculated as the final individual weight divided by the number of people (of all ages) in each household. This weight was applied to each case in the dataset (one case per household member, whether interviewed or not).

7.3. Weighting procedures – quota sampling (sample design 4)

In Luxembourg, no population figures could be obtained on which to base the weighting. Therefore, a uniform weight was calculated to gross the weighted sample to the total estimated population size. For sample frames for the source used, see [Table 4.11](#).

7.4. Weighting efficiency

Table 7.1 provides the range and ratio (largest to smallest) of the final individual and household weights for each country and target group (standardised to a mean of 1 for each sample). It also provides the weighting efficiency of the samples. This is calculated as the ratio of the effective sample size to total sample size. The effective sample size is calculated using the standard Kish formula (sum of weights squared divided by sum of squared weights). The efficiencies therefore do not take account of the impact of clustering or stratification.

In the majority of countries, the total weighting efficiencies shown here are similar to the levels predicted at the design stage (see [Table 4.12](#) and [4.13](#)), when efficiencies were estimated based on whether or not, and to what extent, the designs oversampled areas of higher target group concentration (made for non-location sampling samples). Of these, the majority of samples are within 50 % of the design-based levels presented in [Table 4.13](#), meaning that the disproportionate sample design contributed at least two thirds of the efficiency loss in these countries. Further reductions in efficiency can broadly be explained by the impact of the additional planned weighting stages (random selection of individuals for interview; household and individual level non-response weighting; and post-stratification weighting regional adjustments). Six samples are above this level (the Czech Republic, Hungary, Portugal, Romania, Slovakia and Spain (Roma)), i.e. all except three of the Roma samples. The Roma samples were further impacted by (i) the selection of one individual per household (instead of two) which requires larger weights; (ii) reducing the size of the sample during fieldwork to avoid delivering too many interviews which increased weight variation (this was required in Hungary, Portugal, Romania and Spain); and (iii) the use of ACS which requires additional weighting adjustments.

Table 7.1: Range and efficiency of final individual (ind) and household (hh) weights

Country	Target group	Range (ind)	Ratio (ind)	Efficiency (ind) (%)	Range (hh)	Ratio (hh)	Efficiency (hh) (%)
AT	SSAFR	0.14–1.42	10.1	84	0.05–2.83	56.6	62
	TUR	0.18–4.99	27.7	54	0.18–12.95	71.9	44
BE	NOAFR	0.05–4.6	92.0	55	0.04–7.85	196.3	49
	TUR	0.14–5.06	36.1	52	0.06–13.03	217.2	38
BG	ROMA	0.11–3.49	31.7	69	0.15–3.68	24.5	75
CY	ASIA	0.26–7.08	27.2	53	0.13–5.83	44.8	50
CZ	ROMA	0.06–4	66.7	66	0.05–4.5	90.0	69
DE	SSAFR	0.35–3.57	10.2	75	0.18–6.21	34.5	59
	TUR	0.01–4.14	414.0	60	0.01–7.84	784.0	55
DK	SSAFR	0.3–3.63	12.1	71	0.13–11.43	87.9	46
	TUR	0.23–2.42	10.5	79	0.17–4.95	29.1	69
EE	RUSMIN	0.15–2.79	18.6	76	0.09–2.85	31.7	83
EL	ROMA	0.19–2.92	15.4	76	0.2–3.39	17.0	81
	SASIA	0.2–5.11	25.6	46	0.07–5.73	81.9	43
ES	ROMA	0.08–7.71	96.4	53	0.06–5.53	92.2	58
	NOAFR	0.1–5.82	58.2	51	0.1–7.59	75.9	47
FI	SASIA	0.3–1.21	4.0	90	0.1–3.7	37.0	57
FR	SASIA	0.07–5.66	80.9	53	0.05–15.52	310.4	42
	NOAFR	0.12–5.47	45.6	51	0.06–15	250.0	41
HU	ROMA	0.05–7.16	143.2	43	0.06–11.08	184.7	45
HR	ROMA	0.26–2.85	11.0	78	0.23–10.18	44.3	76
IE	SSAFR	0.11–6.22	56.5	36	0.07–8.76	125.1	34
IT	SSAFR	0.07–8.52	121.7	31	0.06–11.48	191.3	30
	NOAFR	0.02–6.74	337.0	32	0.02–12.51	625.5	35
	SASIA	0.04–7.2	180.0	35	0.06–13.51	225.2	36
LT	RUSMIN	0.25–3.51	14.0	71	0.13–2.79	21.5	76
LU	SSAFR	1–1	1.0	100	0.38–3	7.9	69
LV	RUSMIN	0.2–4.18	20.9	63	0.14–3.71	26.5	69
MT	SSAFR	0.13–3.94	30.3	66	0.09–7.58	84.2	52
NL	NOAFR	0.18–3.83	21.3	63	0.08–12.48	156.0	44
	TUR	0.13–4.71	36.2	56	0.06–13.86	231.0	36
PL	RIMGR	0.17–2.83	16.6	78	0.08–5.52	69.0	65
PT	ROMA	0.11–5.47	49.7	52	0.13–6.28	48.3	54
	SSAFR	0.24–4.36	18.2	63	0.15–10.56	70.4	51
RO	ROMA	0.08–3.67	45.9	64	0.1–6.14	61.4	65
SE	SSAFR	0.12–2.04	17.0	73	0.04–5.5	137.5	46
	TUR	0.01–2.24	224.0	73	0.01–6	600.0	45
SI	RIMGR	0.23–2.22	9.7	86	0.1–4.62	46.2	58
SK	ROMA	0.09–3.74	41.6	66	0.11–7.22	65.6	67
UK	SSAFR	0.07–4.6	65.7	58	0.03–10.96	365.3	48
	SASIA	0.08–7.06	88.3	42	0.04–12.06	301.5	34

Notes: ASIA, immigrants and descendants of immigrants from Asia; NOAFR, immigrants and descendants of immigrants from North Africa; RIMGR, recent immigrants; ROMA, Roma; RUSMIN, Russian minority; SASIA, immigrants and descendants of immigrants from South Asia; SSAFR, immigrants and descendants of immigrants from Sub-Saharan Africa; TUR, immigrants and descendants of immigrants from Turkey.

Source: FRA, EU-MIDIS II 2016

8

Lessons learned

FRA's Founding Regulation requires the agency (Article 4.1b) to develop methods and standards to improve the comparability, objectivity and reliability of data at the European level. This technical report outlines in detail how the data for the EU-MIDIS II survey were collected. Information on how the data collection was implemented provides insight in terms of interpreting the results, but details of the data collection process also contribute to the iterative improvement of survey methodologies. EU-MIDIS II is an indispensable and unique source of information for policy development and evaluation in the area of fundamental rights. Its methodology is based on approaches developed for EU-MIDIS I in 2008 – the first ever survey on immigrants and ethnic minorities in all EU Member States – and the Roma pilot survey in 2011.

In the past decade, the demand for data on immigrants and ethnic minorities has increased. This is also reflected in the European Commission's efforts to prepare, evaluate and present indicators on immigrant integration (the 'Zaragoza indicators'),⁴⁷ and related studies.⁴⁸ For example, while the data on immigrant integration that Eurostat prepared⁴⁹ represent a key source for these indicators, they cannot satisfy all data needs. The data on immigrant integration are mainly based on EU's high quality data collection tools, including the EU Labour Force Survey (EU-LFS), EU Statistics on Income and Living Conditions (EU-SILC) and Eurostat's migration statistics, as well as OECD's Programme for International Student Assessment (PISA). Many of the existing sources of survey data are general population surveys. Although these are the best sources of comparable data in their respective areas, data are

still lacking for some countries, for some target groups and on some topics, given that surveys of the general population are severely limited when it comes to providing data on immigrants. This lack of data is a result of low samples of immigrants in general population surveys in some countries, so data and indicators are unavailable and/or do not allow additional breakdowns for particular groups. For example, it is difficult to collect data from a high-quality sample of immigrants in countries where they constitute a low share of the total population, for example in some Central and Eastern European countries, such as Bulgaria, Poland or Slovakia. It is also not possible to obtain information on immigrants and descendants of immigrants from Sub-Saharan Africa in most EU Member States, because they make a small proportion of the total population. At the same time, certain ethnic minorities and immigrants and their descendants are particularly vulnerable to various disadvantages and violations of their fundamental rights. Some of the information needed to assess and evaluate existing policies is not available from existing data sources, most notably data on discrimination against and victimisation of vulnerable groups. Furthermore, existing general population surveys do not always ask questions that would enable identification of ethnic minorities and immigrants and descendants of immigrants in the sample, or use of the survey to analyse their experiences.

To obtain information and data about particular vulnerable groups, efforts such as EU-MIDIS II are necessary to provide information that helps to design policies better. EU-MIDIS II fills a gap in data availability and contributes to the further development of methods to gather information about groups that are considered hard to reach or difficult to survey.

This technical report is a source of information for promising practices in collecting data about ethnic

⁴⁷ Council of the European Union (2010).

⁴⁸ Eurostat (2011); Huddleston, T. *et al.* (2013); OECD (2015).

⁴⁹ See the Commission's [webpage on migrant integration statistics](#).

minorities and immigrants, at the international and national levels. It not only provides a benchmark in terms of full transparency concerning data collection methods used, but should also help researchers to improve the design of future studies and surveys covering hard-to-reach groups.

The following points were observed in the course of the project and deemed important to take into account when designing a survey on ethnic minorities, or immigrants and descendants of immigrants, in the future.

Before developing and deciding on any survey design, collecting background data and information on composition and concentration of the groups to be surveyed is an important task for every data collection. An informed decision on the best possible sampling design can only be taken after a comprehensive mapping of information on the target population in each country to be surveyed. The extensive background data collection carried out in EU-MIDIS II was crucial to the success of the survey.

The results of the cognitive pre-test study of EU-MIDIS II proved indispensable for a sound understanding of whether or not respondents with diverse backgrounds understood the question wording, and the specific terms used, as the research team intended. The outcome of the pre-test informed the final revision of the questionnaire for the pilot and the full-scale survey. Future surveys could also consider the need to develop an easy-to-read version of the questionnaire for persons with learning difficulties, as a simplified version of the questionnaire could also help in overcoming cultural, language and cognitive barriers.

Translation procedures play a central role in multinational and multicultural surveys. FRA used the so-called TRAPD (translation, review, adjudication, pre-testing, and documentation) team translation model, a team-based approach to survey translation. It proved very successful and can be recommended for future EU-wide surveys of persons with ethnic minority or immigrant background. As already recommended in existing survey literature,⁵⁰ the documentation of each step of the translation process (for example in an Excel format) was used as a quality assurance and monitoring tool. For complex projects with diverse target groups and different languages – such as EU-MIDIS II – the planning, scheduling and documentation of the translation process should be done very carefully, and sufficient time needs to be reserved for this step.

Cooperation with National Statistical Institutes (NSIs) is of major importance for the success of surveys that aim to achieve a properly designed probability sample. The NSIs often have access to high quality sampling frames

of the general population, and in some countries these sampling frames can also be used for surveying immigrants and ethnic minorities. When data collection is not carried out by the NSIs themselves, however, there may be restrictions concerning access to certain sampling frames. The experience in EU-MIDIS II showed that requests for cooperation with NSIs cannot be made on a 'one size fits all' basis, because of the survey's complex sampling approach. Instead, requests for data had to be bilaterally negotiated with the NSIs and tailored to the needs of each country and to the specific requirements of the survey. It was therefore important to start well ahead of fieldwork to contact the NSIs and explore opportunities for cooperation and request relevant population data. Some of the delays or interruptions of fieldwork experienced in EU-MIDIS II were due to delays in getting access to the relevant sampling frames.

Meetings with local survey companies that undertake fieldwork should take place immediately after the inception meeting with the contractor and before the background research is completed, to better inform work related to sampling frames.

EU-MIDIS II used a relatively complex screening procedure to identify potential respondents: In many cases questions on country of birth and country of birth of parents or questions on self-identification with a specific minority group had to be made at the doorstep to determine if anyone in the household was eligible to participate in the survey. Based on experiences and difficulties reported from the pilot phase, the interviewer training prepared for the full-scale survey included a sufficient number of practical how-to examples for dealing with various situations that might arise during the screening. This included showcards with maps, to explain the countries included in the definition of the target group interviewed, as well as lists of countries or groups to identify with. As a result, screening based on the country of birth and parents' country of birth worked quite well.

Selecting the most qualified interviewers is very important because it affects data quality. For that reason, when surveying dispersed or hard-to-reach groups using a complex screening procedure, such as the one used in EU-MIDIS II, arrangements for the interviewers' pay should be checked to make sure that they are compensated not only for the interview but also for the screening process.

Cultural and ethical training of interviewers should be part of every survey on ethnic minorities and other minority groups. Country-specific stereotypes and prejudices can be addressed in trainings, which helps interviewers to respect the guidelines and rules in the field. The training sessions for interviewers in EU-MIDIS II addressed cultural and ethical aspects, but

⁵⁰ Survey Research Center (2016).



field controls showed – in particular at the start of the survey – that additional training would have benefited some interviewers. Gender matching – female respondents interviewed by women and male respondents by men – is essential in some communities, particularly Muslim ones. In addition, matching interviewers and respondents on the main language of the respondent should be made whenever possible. That may improve cooperation and willingness to participate, and increase the quality of the data collected.

Traditional and well-tested survey methods should be preferred over new methods that are not fully tested in the field. Alternatively the new methods should be piloted before implementing them on a larger scale. For example, random route procedures are well established as a method of probability sampling, compared with random selection procedures at locations such as open places. However, if traditional methods are not feasible, as was the case in several countries for EU-MIDIS II, alternative methods must be implemented to obtain the data. The implementation of such methods, which are theoretically well founded, can be challenging in practice – for example, if interviewers are not used to stopping people on the street systematically to ask for an interview. This can result in interviewers applying selection procedures differently. Well-designed and comprehensive training of interviewers minimises this problem, so they can avoid mistakes and guarantee to collect high-quality data. Methods applied and experiences gained during a survey should always be reported transparently. That helps to improve such methods and will increase the quality of any future data collection efforts.

Surveying groups without sampling frames or without fully accurate sampling frames is challenging and therefore different assumptions – for example, on the levels of concentration, eligibility, or response rates – have to be made before starting the fieldwork. In EU-MIDIS II, the allocation of sample sizes and number of interviewers engaged was based on several assumptions related to concentrations of the target population and the expected response rates in the Primary Sampling Units (PSUs). To minimise the risk to the survey in case the initial assumptions would be challenged, as data collection progresses, dropping and stopping rules were defined before commencing data collection. The rules applied in the EU-MIDIS II worked well and were applied only in a few cases. However, in some cases actual concentrations and response rates deviated considerably from early assumptions, which produced either insufficient number of interviews or more interviews than expected and planned. Therefore, implementing a staggered sampling approach is recommended. That means releasing the sample in stages, to be able to correct the number of addresses over time while simultaneously ensuring a proper random sampling.

In EU-MIDIS II, the national survey companies often underestimated the response rates, mostly because these were based on experiences with surveys of the general population. Interest in the survey was high among the target group populations, which resulted in unexpectedly high participation rates in some countries. When the topic of the study is of direct interest to the respondents, as with discrimination experiences in EU-MIDIS II, participation rates can increase considerably.

Field control for a total of 41 target groups in 28 countries was done through the local contractors who entered information into a central reporting tool, informing on different parameters of progress of the fieldwork on a weekly basis, combined with monthly progress reports. It is important to ensure that such a reporting tool is completed on time and in detail by all country teams.

To handle the monitoring of the fieldwork in an EU-wide comparative setting, a centralised computer system is recommended, operating on a single platform for collecting and recording data from the screening process and interviews. This would also help to minimise paper administration of the screening process, and enable accurate and real-time monitoring and timely interventions.

EU-MIDIS II also developed and applied sampling methodologies that had not yet been employed in cross-country comparative settings.

- **Adaptive Cluster Sampling (ACS)** was developed to increase the efficiency in terms of screening and related costs and to fully comply with the principle of self-identification in data collection on ethnicity. The plan was to use ACS in all countries where EU-MIDIS II interviewed Roma, as well as in France⁵¹ in PSUs with less than 25 % concentration of the target population. Difficulties with the implementation of ACS were encountered in some of the countries where ACS was implemented. Interviews had to be deleted from the dataset where there were doubts about whether or not the ACS procedure had been followed correctly. The incorrect use of ACS in some instances included finishing ACS chains too early or continuing chains when they should have been brought to an end. In Romania and Bulgaria, ACS significantly increased efficiency of screening. Despite the challenges related to the correct implementation of the procedure, the method is deemed suitable for surveying ethnic minorities. Nevertheless, when applying ACS it is necessary to pay close

⁵¹ Due to legal restrictions related to data collection on ethnicity in France, it was preferable to use ACS in France as compared with FE, where neighbours are asked about persons' country of birth.

attention to thorough training of the interviewers, and to find further ways of simplifying the ACS application rules, as well as ensuring that fieldwork is carefully monitored.

- **Focused enumeration** (FE) was clearly easier to implement in the field than ACS, and could be used when it is deemed acceptable for persons to be asked about their neighbours' ethnicity or origin. Monitoring of the fieldwork and screening seemed easier with FE than with ACS, in particular when address lists were available and all addresses could be pre-printed on the contact sheets that the interviewers used. However, it is important to highlight that the final decision on respondent eligibility should always be left to the respondents themselves.
- **Location sampling** proved to be a feasible alternative to the standard sampling procedures when the target population is highly dispersed and/or cannot be reached with standard survey methodologies. A prerequisite for this method is the assumption that most of the target population can be found at pre-selected locations, centres and areas. It is important to spend enough time to create a comprehensive list of all possible locations where the target

group might congregate, as the sample will be only as good as the list of locations. Some locations, such as counselling offices, churches or associations, are not public places. A further challenge involves convincing the gatekeepers in these locations to cooperate and allow interviewers to carry out the fieldwork autonomously at the location. Moreover, it is essential to have good estimates in advance of the size of the target population at each of the locations (relative to each other) as this increases the efficiency of the sample. Interviewing at a location, once it is selected and access is granted, is easier than with a random route approach. However, making estimates precise, gaining access to the location and applying the selection rules properly requires a large amount of preparatory work, which can be time intensive and costly. Implementing location sampling in EU-MIDIS II showed that standardisation of procedures across locations and countries is difficult, and that respondent selection and steps taken to ensure access to the location have to be tailored to the specificities of locations. Further development is necessary related to quality control of the selection procedure at locations, as it is difficult to check after fieldwork whether or not the selection procedures were correctly implemented at a location.



Annex 1: Questionnaire flowchart

The full questionnaire can be accessed on FRA's website. The chart below gives an overview of the topics covered by the questionnaire.

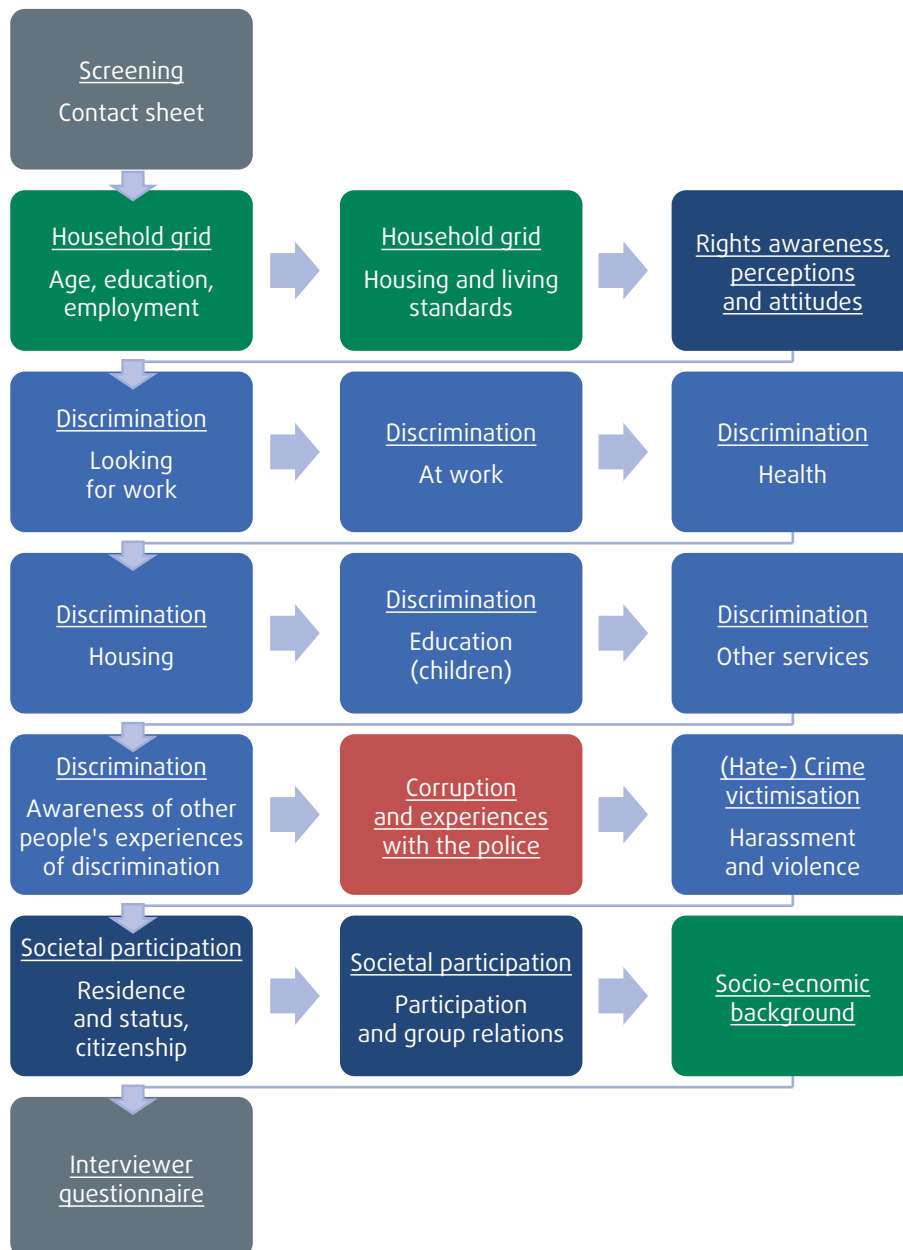

Source: FRA, EU-MIDIS II 2016

Annex 2: Local contractors for fieldwork

Country	Partner agency
Austria	IFES
Belgium	Ipsos Belgium
Bulgaria	Ipsos Bulgaria
Croatia	Ipsos Croatia
Cyprus	CMR Cypronetwork
Czech Republic	Median
Denmark	DMA Research
Estonia	Faktum & Ariko
Finland	Taloustutkimus
France	Ipsos France
Germany	Ipsos Germany
Greece	Ipsos Opinion
Hungary	Ipsos Hungary
Ireland*	Ipsos MRBI
Ireland**	Red C
Italy	Ipsos Italy
Latvia	SKDS
Lithuania	RAIT
Luxembourg	TNS ILRES
Malta	Ipsos Misco
Netherlands***	PMR
Netherlands****	Labyrinth
Poland	Ipsos Poland
Portugal	Ipsos Portugal
Romania	Ipsos Romania
Slovakia	Median
Slovenia	Ipsos Slovenia
Spain	Ipsos Spain
Sweden	Ipsos Sweden
United Kingdom	Ipsos MORI

Notes: * Ipsos MRBI was involved until May 2016.
 ** Red C was appointed in June 2015.
 *** PMR was involved until August 2015.
 **** Labyrinth was appointed in October 2015.

Source: FRA, EU-MIDIS II 2016



Annex 3: Quality assurance plan

Objective	Quality criteria
Achievement of a (random) probability sample representative for the target groups within each country	PSUs drawn from suitable up-to-date registers and data sources where available.
	Development of sampling based on statistical grounds and optimising between precision, feasibility and costs, by collecting data for each target group in each country.
	Comprehensive mapping exercise with statistical provision of distribution of target groups on the level of enumeration districts (if not available on the most detailed regional level), covering indicators for each country.
	<ul style="list-style-type: none"> The 'rarity' of the population (for each target group) overall and on regional level (by reporting the size of the target group overall and in each region, and its percentage of the total population).
	<ul style="list-style-type: none"> Geographical concentration of the target group. This should be based on data at the smallest territorial level available/feasible (PSUs), considering all available data sources such as registers and Census 2011 data. This statistical mapping should cover the entire country, including PSUs with low or no density of the target population. Reporting the target population coverage which can be achieved at different levels of minimum concentration, at a national level.
	<ul style="list-style-type: none"> In countries where centre location sampling is to be considered, further research to be undertaken to identify centres within selected concentrated areas (generally to be drawn from the areas included in the address sampling). This should not be defined too narrowly but will need to factor in what centres can be accessed by interviewers. Include the order of magnitude, with estimates if necessary (to be undertaken after developing address-sampling strategies).
	<ul style="list-style-type: none"> Assessment of difficulty of surveying the group and any social network aspect of that particular group.
	<ul style="list-style-type: none"> Qualitative assessment: How reclusive is that population?
	<ul style="list-style-type: none"> Establishing if telephone screening lists are available, collecting information on source(s) and assessing their possible use.
	<ul style="list-style-type: none"> Identification of information primarily for first generation, and for second generation if available. Census 2011 includes 'country of birth' for all countries. In LFS as a proxy nationality (distinguishing three categories: country of residence, another EU country and non-EU country), years of residence in the country, country of birth (again distinguishing only three categories) and region (NUTS2, NUTS3 on national request). Years of residence in the country is a useful variable for distinguishing 'recent migrants' in all the migrant groups.
	Documentation of coverage per target group on the level of PSU and nationwide.
	Documentation of optimised statistical cut-off point with regard to costs and precision.
	Use of an appropriate sample design reflecting the country requirements: single or two-stage stratified sampling.
	Minimising and estimating design effect for sampling strategies.
	Stratification of the sample by region and urbanisation level using the most recently available population figures.
	Specification of targets for response rates on a local level, taking into consideration different sampling strategies and fieldwork conditions. To be reported per interviewer and local unit (to be specified after developing sampling strategies).
	Minimum number of interviews per target group in each country (to be specified after developing sampling strategies) to be completed.
Enumeration process documented on the PSU level. Two-phase enumeration is required if no other measures can be put in place to quality assure random walk procedures.	
Development of a reliable statistical procedure to replace unsuccessful PSUs.	

Objective	Quality criteria
Sampling plan is documented and reported, including measurement and systematic documentation of sampling errors	Submission of a sampling report containing source of population statistics, information on sample size (gross and net), information on the stratification of the population, sampling method, sampling design and description of sampling stages, sampling frame and its coverage and date, definition of PSU (primary sampling unit), number of sampling points and maximum cluster size.
Random probability and random sampling is ensured	<p>Where required, enumeration by trained enumerators who will not be carrying out interviewing in the PSU they enumerate.</p> <p>Enumeration checking containing the percentage of routes with full compliance, small errors and systematic deviation, but carried out randomly (e.g. random procedure always to the left instead of to the right).</p> <p>At minimum 10 % of the routes must be checked against the selection rule.</p> <ul style="list-style-type: none"> • In case of non-compliance, all routes/PSUs of the enumerator will be rechecked and if necessary replaced. In that case it will be necessary to enumerate the route/PSU again. <p>Documentation of remuneration schemes for enumeration and for interviews to ensure incentive to deliver high quality.</p>
Correction for unequal selection probability within each stage of sampling	<p>Following the sampling scheme, weighting schemes are developed under the lead of the senior sampling and weighting expert.</p> <p>All design weights are controlled for, reflecting accurately the sampling approach. Post-stratification shall be based on the best available source and controlled for between country comparability.</p> <p>Where data are available, non-response adjustment weights are included in the weighting scheme.</p> <p>All weighting steps are documented – design weights, non-response weights, post-stratification weights, cross-national weights, personal and household weights – and included as variables in the final data set and documented in the final technical and quality report with core parameters.</p>
The questionnaire is systematically tested prior to the data collection	<p>A pilot is carried out with randomly selected respondents from each target group over a period of two weeks in each EU Member State.</p> <ul style="list-style-type: none"> • All participating countries are covered, with at least 20 to 30 interviews per country (depending on the number of groups to be surveyed), and including all target groups in each country, as far as possible. • CAPI is tested for comparability between countries and CAPI systems. CAPI checks are developed after the pilot. <p>Submission of pilot dataset and final pilot report (including country-specific reports). The report presents an analysis of a) adequacy and feasibility of the proposed sampling approaches; b) usability and functioning of the questionnaire, the question routing and the instrument’s technical design; c) equivalence of the survey instrument across languages (focus on quality of questionnaire translation); d) collection of meta- and paradata; e) different practices of interviewing. On the basis of the pilot report, revisions and recommendations are made before commencement of the fieldwork.</p> <p>Debriefing of pilot interviewers.</p>



Objective	Quality criteria
Statistics are compiled on the basis of common standards with respect to scope, definitions, units and classifications in the various surveys and sources	Replication of standards from previous cross-national studies on education, qualifications and occupation, with a focus on core variables of the European Statistical System.
The translated questions are comparable and consistent over time, across countries and across populations (language groups)	The comparability of Translated questions is ensured; with regard to: same meaning; same question format; same measurement properties (range of response options); the original stimulus is maintained.
	Translation procedure: team based, TRAPD procedure.
	Translations are validated by FRA (including the submission of a translatability report).
	Use of glossary of terms to translate key terms in the same way in each country (terms to be taken partly from the existing FRA glossaries, InterActive Terminology for Europe).
Questions and fieldwork material are understood by all respondents (in the same way) and can be answered correctly to reduce non-response bias	Translation of the information letter into 10 languages (in addition to 26 core languages) according to sampling mapping exercise.
	Relevant foreign-language paper versions of the questionnaire for respondents having difficulties answering questions in the national language (to be specified based on the results of the mapping exercise for sampling).
Accuracy of Fieldwork documents and CAPI system	All fieldwork documents checked for correctness (glossary, show cards, contact sheet, introduction letter, national briefing documents, etc.).
	CAPI testing is through technical and content checks (including routing of the questionnaire), via a central dummy data file (in particular, filters and answer options).
	If the application of automated survey systems is not feasible in some countries, interviews are carried out using paper questionnaires upon prior approval by FRA.
Experienced interviewers facilitate successful interview implementation	Interviewers have at least 3 months' experience working as market and social research interviewers, and most will have substantially more.
	No interviewer to conduct more than 5 % of the total sample. If there are specific reasons for an interviewer to exceed this (such as language/cultural sensitivities, etc.), the CCT will review this before giving approval.
	Recruitment of 10–15 % more than the number of interviewers needed in each Member State to allow for attrition and possible dismissal of interviewers.
	Recruitment of a pool of interviewers that, where possible, allows: 1) matching of respondents and interviewers by specific characteristics (gender, age, language skills, ethnic minority/immigrant background); and 2) using pairs of interviewers.
	Information on the interviewers is to be recorded and provided in an interviewer register, with a unique identifier to be linked with each interview: gender, age and ethnicity (with consent); dates of training received; and language skills.

Objective	Quality criteria
<p>Uniform and detailed information are provided on all aspects of the fieldwork (e.g. contact procedure, interviewing, data entry, quality control, etc.)</p>	<p>Each national agency receives a briefing document, including a detailed project timetable, a list of the national agency’s responsibilities during each phase of the project and an outline of the lines of communication between the CCT and the national agencies (including contact information).</p>
	<p>Central briefing in Berlin for all NSEs, and briefing materials to conduct their national interviewer briefings.</p>
	<p>Standardised training materials are developed on the basis of the pre-test study and feedback from expert consultation (including information on sampling strategy, selection of respondent, structure of questionnaire, ensuring confidentiality and privacy, dealing with sensitive and distressed respondents, and use of fieldwork materials).</p>
	<p>Participation by all interviewers in a two-day in-person local interviewer training session held by the NSE in each country, and based on the interviewer training manual. Any interviewers who are recruited to work on the project after fieldwork commences will be required to complete a separate briefing session with the NSE, lasting 1 day. (If PAPI mode is used, additional time training days focusing on PAPI interviewing need to be allocated.)</p>
<p>Data collection, data entry and coding are routinely monitored and revised as required</p>	<p>Regular quality checks of CAPI data conducted by national agencies throughout the fieldwork phase (data checking guidelines are provided), and by the CCT, checking for:</p> <ul style="list-style-type: none"> • high levels of item non-response; do not know/refusal response; conspicuous consistency in response items; interview length; outliers; interventions in the interview; completeness and consistency in contact sheet and household grid; reliability of metadata; and start/end times of interviews.
	<p>CAPI data uploaded at several points (after completion of 10 %, midway through phase 1, end of phase 1 and 100 % of interviews) during the fieldwork, and quality control checks carried out by the CCT.</p>
	<p>Interviews with more than 25 % of item non-response are not considered complete.</p>
	<p>Interviews with missing household grid not considered complete.</p>
	<p>Basic core variables are checked for completeness.</p>
	<p>Incomplete, inconsistent and erroneous interviews to be checked back and completed or replaced.</p>
<p>Consistency and accuracy in data collection between countries</p>	<p>A standardised questionnaire used in all countries (with the exception of items tailored to country).</p>
	<p>Use of standardised interviewing technique: carrying out face-to-face interviews in each country with use of automated survey systems (CAPI).</p>
	<p>Minimum net sample size of 25,200 respondents across the EU (15,200 Phase 1; 10,000 Phase 2) with optimal allocation of sample among target groups and countries.</p> <ul style="list-style-type: none"> • The entire gross sample shall be drawn in Phase 1.
	<p>Coding of regional and address information so that survey data can be linked to external contextual/auxiliary data (e.g. NUTS3, LAU2, DEGURBA).</p> <ul style="list-style-type: none"> • All metadata and paradata are linked to the survey data via a unique identifier.
	<p>Aim of a minimum overall response rate of 50 % within each EU Member State and a minimum response rate of 40 % within each PSU and each target group.</p>
	<p>Contact procedure is detailed in the interviewer manual and interviewer instructions, and addressed during central briefings and local interviewer training.</p>
	<p>Where possible, working together with local mediators or facilitators, such as representatives of local communities or civil society organisations who can help establish cooperative relationships within certain groups or communities (especially with Roma).</p>
	<p>To enable non-response analysis, information recorded on contacts and non-contacts is collected (relevant meta-/paradata, e.g. stratification characteristics, survey process characteristics, results of various stages of the process).</p>



Objective	Quality criteria
Fieldwork is documented and monitored continuously with respect to quality criteria	Each interviewer uploads their interviews at the end of each working day to the head office of each country.
	The contact sheet information will be captured electronically so that data can be linked to each dataset and interviewer. This will be carried out via a unique identifier at data entry.
	Each week, completed paper contact sheets are sent back.
	Weekly updates by national agencies in the fieldwork phase are sent to the CCT, addressing: <ul style="list-style-type: none"> • changes in resources and personnel; number of interviews and random walks back checked; number of CAPI data checking rounds completed; response rate; basic demographic profile of respondents; outcomes of non-response and non-contacts analysis; qualitative information collected during fieldwork).
	Provision of an interim report to FRA in the middle of the fieldwork phase. The report is divided into information on each country and outlines fieldwork developments with respect to 1) progress, 2) challenges and 3) solutions implemented. (Addressing: a) selection and application of population sampling frames and approaches; b) selection of interviewers and enumerators; c) respondent screening; d) reaching respondents; e) interview success rate/(non-)contact and (non-)response rate.)
	Final quality control report to be provided by national agencies at the end of the fieldwork.
	Submission of field progress reports to FRA on a weekly basis. These field reports are set up so that progress can be monitored easily, and should include: <ul style="list-style-type: none"> • information on how the data collection and the response rates develop based on a) target group, region and interviewer (fortnightly); b) completed interviews, contacts, type of non-response, eligible and non-eligible households; and c) PSUs dropped or exchanged; • information that can be easily viewed and compiled over several time points; • highlighting of critical areas and developments; • issues that emerged in the local fields and how these were addressed; • general and specific measures that were taken to speed up fields that are behind; • number of back checks carried out, and their outcome.
High quality of the work of the interviewers and the response data gathered and optimised quality throughout the field work	Back checking interviews: 10 % of interviews in each country will be back checked by the fieldwork management team in each country throughout the duration of fieldwork.
Interviewers are prevented from working incorrectly or inaccurately	Back checks control for initial contact (contact procedure), use of fieldwork materials, completed interview, household size and core dimensions of the questionnaire.
	If quality is poor, all interviews of the interviewer concerned will be rechecked and if necessary replaced.
Consistency and transparency of data	Guidelines on formatting rules and data checks on country level are provided to national agencies, including instructions to ensure that: <ul style="list-style-type: none"> • all variables are included in each dataset; the base size of each question is correct and reflects the rules of routing; there are no missing values; and the labelling of variables and value labels is clear and correct.

Objective	Quality criteria
Consistency and accuracy of National and merged data file	Each country to convert its data and upload it to a central location.
	Frequency outputs for the country files to be provided to check merged data against the national files.
	Collection and transmission of data with national coding, and documentation of all recoding steps to achieve the harmonised version (harmonisation of variables such as level of education and income).
	Merging of data collected in Phase 1 and Phase 2 and submission in SPSS format.
	Merged data to be checked for consistency and validity by the CCT: <ul style="list-style-type: none"> • high levels of item non-response, do not know/refusal response, conspicuous consistency in response items, interview length outliers, start/end times of interviews; • correctness of base sizes at each question and reflection of the rules of the routing in the questionnaire, and correctness against the frequency tables provided by countries, ensuring that there are no missing data and that all labelling of variables and values is clear; • error rates.
Complete and anonymised delivery of the data	The quantitative data collected from the interview and interviewer debriefing forms are submitted in an SPSS-compatible computer file.
	A second data file is submitted containing meta- and paradata on the gross sample (information on sampling, address information, contact information, PSU, GPS coordinates, regional information, degree of urbanisation, incentives, mode).
	The data file is anonymised and sensitive information on the address or GPS coordinates are handled in compliance with data protection rules.
	Files are fully documented in a codebook (variable names and value labels) including metadata, paradata, interviewer data and sampling information.
	Provision of a report on the calculation of selected indicators (including SPSS code).
Data editing and cleaning is documented with respect to quality criteria	Provision of a data editing and cleaning report.
	The Code (SPSS syntax or similar) related to data file construction, and used to produce the quality checks, data coding and labelling, is submitted in electronic format.
Deadlines are kept as agreed in the inception meeting, in accordance with the agreed timetable and the time schedule of the overall deliverables of the project	Tasks are carried out and deliverables are submitted according to the agreed timetable.
	All tasks are completed within 16 months from the contract signature unless there are agreed changes to the timetable.
Regular updates to FRA are provided as an 'early-warning' system regarding overall project progress	Monthly updates on the progress of the project in all countries are provided to FRA by the project coordinator, using feedback from the National Survey Experts on the first working day of each month: <ul style="list-style-type: none"> • covering all elements of the quality control strategy; • including a record of decisions made in consultation with FRA regarding sampling and fieldwork in each country.
	Weekly progress reports on overall project progress to be submitted by the project coordinator to FRA.
	If quality criteria are not fully met, FRA to be informed immediately.
Quality standards are consistently applied by all participating survey organisations	Organisational and quality standards are set and communicated (e.g. The Quality Assurance Plan).
	A central management and coordination team oversees all aspects of work relating to the survey undertaken in all 28 EU Member States.



Objective	Quality criteria
All aspects of data collection, survey research methodology and quality assurance are thoroughly documented and reported	<p>A final technical and quality report is submitted after completion of the fieldwork, including:</p> <ul style="list-style-type: none"> • information on each country describing the fieldwork with respect to: <ol style="list-style-type: none"> (1) assumptions/plans at the start of fieldwork, (2) outcomes, (3) challenges, (4) quality control measures, and (5) solutions implemented concerning each of the following themes: (a) selection, application and assessment of population sampling designs; (b) geographical coverage and distribution; (c) interviewer selection and training; (d) ethical issues throughout fieldwork; (e) interview success/ (non-)contact and (non-) response rate; (f) interviewer feedback; (g) weighting; (h) coherence and consistency of results; • highlighting of any difficulties that arose in the course of implementing the survey.

Notes: CAPI, computer-assisted personal interviewing; CCT, central coordination team; DEGURBA, degree of urbanisation; LFS, Labour Force Survey; NSE, national survey expert; PAPI, paper and pencil interview; PSU, primary sampling unit; TRAPD, translation, review, adjudication, pre-testing, and documentation.

Source: FRA, EU-MIDIS II 2016

References

- AAPOR (American Association for Public Opinion Research) (2011), *Standard definitions: Final dispositions of case codes and outcome rates for surveys, revised 2011*, Oakbrook Terrace, IL, AAPOR.
- Baio, G., Blangiardo, G., Blangiardo, M. (2011), 'Centre sampling technique in foreign migration surveys: A methodological note', *Journal of Official Statistics*, Vol. 27, No. 3, 2011, pp. 451-465.
- Bonevski, B., Randell, M., Paul, C., Chapman, K., Twyman, L., Bryant, J., Brozek, I., Hughes, C. (2014), 'Reaching the hard-to-reach: A systematic review of strategies for improving health and medical research with socially disadvantaged groups', *BMC Medical Research Methodology*, Vol. 14, No. 42, pp. 1-29.
- Council of Europe (2012), '[Descriptive glossary of terms relating to Roma issues](#)'.
- Council of the European Union (2000), [Council Directive 2000/43/EC of 19 July 2000 implementing the principle of equal treatment between persons irrespective of racial or ethnic origin](#), OJ 2000 L 180, p. 22-26.
- Council of the European Union (2010), [Declaration of the European Ministerial Conference on Integration](#), Zaragoza, 15-16 April 2010.
- Eurofound (2010), '[5th European Survey on Working Conditions questionnaire](#)'.
- European Commission (2014), *Report on the implementation of the EU Framework for National Roma Integration Strategies*, COM (2014) 209 final, Brussels, 2 April 2014.
- European Court of Auditors (2016), *EU policy initiatives and financial support for Roma integration: Significant progress made over the last decade, but additional efforts needed on the ground*, Special report, Luxembourg, Publications Office of the European Union (Publications Office).
- Eurostat (2011), *Indicators of immigrant integration: A pilot study*, Luxembourg, Publications Office.
- Eurostat (2016), '[People at risk of poverty or social exclusion](#)'.
- Eurostat (2017a), '[European Health Interview Survey \(EHIS\)](#)'.
- Eurostat (2017b), '[European Union Statistics on Income and Living Conditions \(EU-SILC\)](#)'.
- FRA (European Union Agency for Fundamental Rights) (2009), *EU-MIDIS: Main results report*, Luxembourg, Publications Office.
- FRA (2013), *Roma Pilot Survey – technical report: Methodology, sampling and fieldwork*, Luxembourg, Publications Office.
- FRA (2014), *Roma Survey – data in focus: Poverty and employment: The situation of Roma in 11 EU Member States*, Luxembourg, Publications Office.
- FRA (2016), *European Union Minorities and Discrimination Survey: Roma – selected findings*, Luxembourg, Publications Office.
- FRA and United Nations (2016), *Surveying hard-to-reach groups from a comparative cross-country perspective: The second European Union Minorities and Discrimination Survey (EU-MIDIS II): Note by European Union Agency for Fundamental Rights (FRA)*, Geneva, Economic Commission for Europe.
- Groves, R. M., Fowler, F. J., Couper, M., Lepkowski, J. M., Singer, E., Tourangeau, R. (2009), *Survey methodology*, Wiley Series in Survey Methodology, Hoboken, N.J., Wiley.
- Huddleston, T., Niessen, J. and Tjaden, J. (2013), *Using EU indicators of immigrant integration*, Brussels, European Commission.
- OECD (Organisation for Economic Co-operation and Development) (2015), *Indicators of immigrant integration 2015: Settling in*, Paris, OECD.
- OHCHR (United Nations Human Rights Office of the High Commissioner) (2016), *A human rights-based approach to data: Leaving no one behind in the 2030 Development Agenda*, Geneva, OHCHR.
- Reichel, D. and Morales, L. (2017), '[Surveying immigrants without sampling frames: Evaluating the success of alternative field methods](#)', *Comparative Migration Studies*, Vol. 5, No. 1, pp. 1-22.
- Schnell, R., Trappmann, M., Gramlich, T. (2014), 'A study of assimilation bias in name-based sampling of migrants', *Journal of Official Statistics*, Vol. 30, No. 2, pp. 231-249.
- Survey Research Center (2016), *Guidelines for best practice in cross-cultural surveys: Full guidelines*, Ann Arbor, MI, Institute for Social Research, University of Michigan.
- Verma, V. (2014), *Sampling elusive populations: Applications to studies of child labour*, Geneva, International Labour Office.

The EU-MIDIS II *Main results* report presents the main findings for all groups surveyed. In addition, two *Selected findings* reports have been published – one focusing on Roma and one on Muslims.



FRA's online data explorer tool will allow for quick access to the full survey data, see <http://fra.europa.eu/en/publications-and-resources/data-and-maps/>.

HOW TO OBTAIN EU PUBLICATIONS

Free publications:

- one copy:
via EU Bookshop (<http://bookshop.europa.eu>);
- more than one copy or posters/maps:
from the European Union's representations (http://ec.europa.eu/represent_en.htm);
from the delegations in non-EU countries (http://eeas.europa.eu/delegations/index_en.htm);
by contacting the Europe Direct service (http://europa.eu/eurodirect/index_en.htm) or
calling 00 800 6 7 8 9 10 11 (freephone number from anywhere in the EU) (*).

(*). The information given is free, as are most calls (though some operators, phone boxes or hotels may charge you).

Priced publications:

- via EU Bookshop (<http://bookshop.europa.eu>).

HELPING TO MAKE FUNDAMENTAL RIGHTS A REALITY FOR EVERYONE IN THE EUROPEAN UNION

FRA's Second European Union Minorities and Discrimination Survey (EU-MIDIS II) surveys around 26,000 individuals from different ethnic minority and immigrant backgrounds across all 28 EU Member States. This technical report presents a detailed overview of the research methods used by FRA when collecting the survey data.

FRA - EUROPEAN UNION AGENCY FOR FUNDAMENTAL RIGHTS

Schwarzenbergplatz 11 – 1040 Vienna – Austria

Tel. +43 1580 30-0 – Fax +43 1580 30-699

fra.europa.eu – info@fra.europa.eu

facebook.com/fundamentalrights

linkedin.com/company/eu-fundamental-rights-agency

twitter.com/EURightsAgency



Publications Office